

PRODUCT CATALOGUE



Compressed air products, air line accessories & tyre inflation equipment

www.pclairtechnology.com



A HORNGROUP BRAND

COUPLINGS & ADAPTORS

HOSE

HOSE FITTINGS

TYRE INFLATION EQUIPMENT

TYRE CARE

NITROGEN EQUIPMENT

WORKSHOP EQUIPMENT

AIR TOOLS

AIR TOOL ACCESSORIES

2021/22

FIRST-CLASS SERVICE – LOCALLY AND ONLINE

PCL is renowned for its excellent customer service and global network of expert partners providing first-class local support

The company's proactive approach to partnering has established PCL as the brand to buy in over 100 countries, with a trusted network of authorised distributors and resellers working to serve customers locally on their doorstep.

Expert, technical advice and support

PCL's partners are always on hand to advise on the best products for individual applications and deliver a first-class aftersales service with trusted technical support. Some distributors specialise in specific markets and products, whilst others offer PCL's full range of pneumatic equipment and tyre inflation equipment. All are industry experts, committed to the PCL brand and dedicated to delivering the excellent customer service the company takes pride in.

Online guidance at your fingertips

In addition to the full package of local support, PCL offers a comprehensive Support & Advice service online. Designed to support customers at every stage of their journey, this website section includes articles detailing how to select the right equipment for individual applications, along with helpful 'How-to' guides and videos to help customers make the most of PCL's compressed air products and tyre inflation equipment.

Enhanced stock and service through Partner+

For customers looking for a broader range of products, distributors who are part of PCL's Partner+ programme typically offer bigger inventories and more extensive technical competences. PCL works closely with these partners to provide enhanced product training and collaborative marketing initiatives. This includes the development of on-site Air Centres, where local businesses can view the distributor's product offering and obtain advice from the PCL team about the safe use of compressed air.

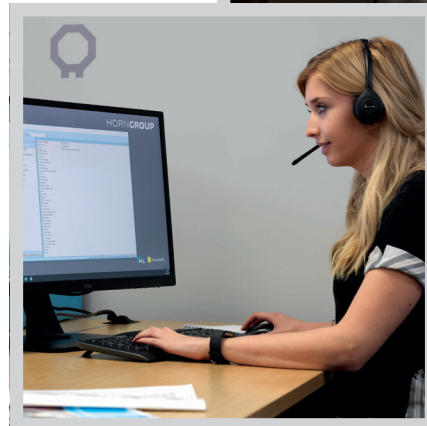



PCL is dedicated to helping its customers develop and prosper through a range of features and benefits.

Comprehensive package

PCL is continually developing its advanced and extensive portfolio of tyre inflation and compressed air equipment to fit any industry need, with bespoke products to meet the demands of local markets.

Built to last

All PCL products are manufactured from the highest quality material with reliability and durability in mind, and thoroughly tested to all (applicable) internationally recognised standards.

Performance

PCL's products out-perform all other comparative brands, with a focus on quality and efficiency resulting in increased production and profit for the customer's business.

Trusted warranties

All products carry a 1-year warranty, and now 2 years on PCL's market-leading AIRFORCE® MK4 and ACCURA® MK4 Tyre Inflators and 5 years on selected couplings.

Why PCL?

PCL has firmly established itself as the international market leader through innovative design and a proactive approach, providing the best products and customer service available...

...for all your pneumatic needs.

Local service, worldwide

A pro-active approach to partnering and pioneering design enables PCL to supply standard and bespoke products, backed up by local customer service and training.

Experience

PCL's unrivalled knowledge and proven track record of manufacturing excellence means customers have access to the best technical expertise and products available.

Technical support

PCL's highly trained experts are on hand to provide customers with full technical assistance, including site visits where necessary.

Dedication to customers

PCL provides a full after sales service, including training and support to sell products, such as bespoke literature and product user manuals.

PCL's dedication to continuous development means customers have access to the most advanced and extensive portfolio of tyre inflation and compressed air equipment available on the market. The comprehensive, world-renowned range can satisfy any industry need, with bespoke products designed to meet the demands of local markets.

ERGO AND ERGO EXTREME BLOWGUNS

Find out more on pages 78-79

ERGO EXTREME affords additional cushioning with a flexible, rubber grip on the handle, which also offers increased strength

Easy to store with multiple hanging points

Range of different nozzles available

Newly designed air release valve built into the body, enabling trigger/air flow to be feathered

Re-enforced webbing - Robust design gives strength and confidence

This range of 'better' and 'best' blowguns has the PCL DNA running right through it, from handle to tip. There are 7 options in each of the ERGO and ERGO EXTREME designs, including 2 bar regulated blowguns and safety nozzles.

Design-engineered in the UK, with comfort and style in mind



ERGO BLOWGUN



ERGO EXTREME BLOWGUN

NEW

AIRLITE ECO LINEAR TYRE INFLATOR

The new entry level Airlite eco Tyre Inflator boasts the engineering knowhow of its highly-respected MK4 'big brother' making it a cost-effective addition to general trade or an auto enthusiast's tool kit.



Find out more on page 45

NEW

Find out more on page 52

SWIVEL CLIP-ON TYRE VALVE CONNECTORS



Now featuring an ergonomic handle, these Swivel Clip-on Connectors are designed for easy operation and boast a vice-like grip.

CH3A01

CH3A02

NEW

Find out more on page 100

13MM REVERSIBLE DRILL



With additional rotatable handle providing enhanced for comfort and precision.

APT413R

NEW

HOSE REELS

Following the launch of the well-received Workshop Hose Reel range, PCL has further extended its portfolio with addition of the original Retracta R3 Polypropylene Hose Reel, renowned worldwide for its performance and reliability.



Retracta Hose Reel Range

Find out more on page 83

NEW

PCL WORM DRIVE HOSE CLIPS

This essential item is available in Mild Steel Zinc Plated or 304 Stainless Steel in a range of popular sizes from 9.5 to 40mm.



Find out more on page 33

COUPLINGS & ADAPTORS



PCL has been designing and manufacturing couplings & adaptors for over 75 years. Within this section you will find the largest selection available, from the standard Airflow range for fixed applications and Vertex for trailing hose, to the common industry interchanges and safety couplings.



Airflow Series

Page 8



Vertex Series

Page 9



Safeflow Series

Page 10



Non-Corrodible Series

Page 11



XF-Euro Series

Page 12

The Airflow Coupling is the original quick release coupling with over 75 years of design enhancements, and along with the Standard Adaptor is still manufactured in the UK to the highest possible standards.



XF-Euro Safety Series

Page 13



Emergency Coupling Kits

Page 14



100 Series

Page 14



60 Series

Page 15



1/2" InstantAir Series

Page 15



InstantAir Series

Page 16



InstantAir Series

Page 16



Standard Schrader Series

Page 17



Heavy Duty Schrader Series

Page 17



Mini Series

Page 18



A Style Series

Page 19



PF Series

Page 19



ISO B12 Series

Page 20



KF Series

Page 20



STANDARD RANGE

AIRFLOW SERIES

BEST SELLER

The Airflow Coupling is the original quick release "PCL" with around 75 years of design enhancement. This product, along with the Standard Adaptor, is still manufactured in the UK to the highest possible standards, with the "Made in Sheffield" Airflow series now a benchmark in the UK for quality and reliability.

Suitable for most compressed air applications - particularly fixed applications where the coupling is used over a workbench and a single action is preferred.

Features

- Single action
- Steel construction
- Corrosive resistant finish
- Benchmark in the UK for quality and reliability
- Designed for fixed applications



INTERCHANGEABLE » RECTUS 19



Part Number	Thread Type	Thread Size
-------------	-------------	-------------

Airflow Couplings

AC21CM	Male	R 1/4
AC21EM	Male	R 3/8
AC21JM	Male	R 1/2
AC21CF	Female	Rp 1/4
AC21EF	Female	Rp 3/8
AC21JF	Female	Rp 1/2
AC21R	Hose Tailpiece	7 mm / 1/4 in
AC21S	Hose Tailpiece	8 mm / 5/16 in
AC21T	Hose Tailpiece	10 mm / 3/8 in
AC6103	Twin Coupling	N/A

- Nominal bore: 4.8 mm
- Flow rate: 43 cfm @ 100 psi
- Maximum working pressure: 14 bar / 200 psi
- Temperature range: -40°C to 100°C

Part Number	Thread Type	Thread Size
-------------	-------------	-------------

Standard Adaptors

ACA2593	Male	R 1/4
ACA6909	Male	R 3/8
ACA6584	Male	R 1/2
ACA2746	Female	Rp 1/4
ACA6582	Female	Rp 3/8
ACA6583	Female	Rp 1/2
ACA2486	Hose Tailpiece	4.75 mm / 3/16 in
ACA1793	Hose Tailpiece	6.35 mm / 1/4 in
ACA2487	Hose Tailpiece	7.9 mm / 5/16 in
ACA2488	Hose Tailpiece	9.5 mm / 3/8 in
ACA9438	Hose Tailpiece	13 mm / 1/2 in

Standard Safety Adaptor

ACA9101	Male	R 1/4
---------	------	-------

Couplings & Adaptors

Hose

Hose Fittings

Tyre Inflation Equipment

Tyre Care

Nitrogen Equipment

Workshop Equipment

Air Tools

Air Tool Accessories



STANDARD RANGE

VERTEX SERIES

Designed and manufactured in Sheffield by PCL, these quick release Vertex Couplings feature a double action mechanism. This makes them ideal in garages and tyreshops, where operators are using air tools or hand held inflators for trailing hose applications.

Features

- Double action
- Protective shoulder helps to prevent dirt penetration
- Steel construction
- Corrosive resistant finish
- Ideal for use in the garage and tyreshop environments
- Designed for trailing hose applications



Part Number Thread Type Thread Size

Vertex Couplings		
AC91CM	Male	R 1/4
AC91EM	Male	R 3/8
AC91JM	Male	R 1/2
AC91CF	Female	Rp 1/4
AC91EF	Female	Rp 3/8
AC91JF	Female	Rp 1/2
AC91R	Hose Tailpiece	7 mm / 1/4 in
AC91S	Hose Tailpiece	8 mm / 5/16 in
AC91T	Hose Tailpiece	10 mm / 3/8 in
AC6503	Twin Coupling	N/A

- Nominal bore: 4.8 mm
- Flow rate: 43 cfm @ 100 psi
- Maximum working pressure: 14 bar / 200 psi
- Temperature range: -40°C to 100°C



Part Number Thread Type Thread Size

Standard Adaptors		
ACA2593	Male	R 1/4
ACA6909	Male	R 3/8
ACA6584	Male	R 1/2
ACA2746	Female	Rp 1/4
ACA6582	Female	Rp 3/8
ACA6583	Female	Rp 1/2
ACA2486	Hose Tailpiece	4.75 mm / 3/16 in
ACA1793	Hose Tailpiece	6.35 mm / 1/4 in
ACA2487	Hose Tailpiece	7.9 mm / 5/16 in
ACA2488	Hose Tailpiece	9.5 mm / 3/8 in
ACA9438	Hose Tailpiece	13 mm / 1/2 in
Standard Safety Adaptor		
ACA9101	Male	R 1/4

INTERCHANGEABLE » RECTUS 19

MATCHING COUPLINGS AND ADAPTORS

Identifying couplings can be difficult, especially if there is no branding etched or printed on the sleeve - and when it comes to adaptors, different profiles do not interchange. For example, an XF adaptor will not fit into a Vertex coupling.

Therefore the most important aspect of identifying couplings and adaptors is to establish their profile.

That's why our brochure places them in series so it's easy to see which fit together, whilst our "actual size adaptor

profile" chart enables adaptors to be matched to the outlines of those shown on the page.

The coupling can then be identified by establishing the adaptor that fits into it using the method above.

PCL couplings and adaptors are manufactured to conform to international standards and are interchangeable with other manufacturers' couplings and adaptors using the same standards.

Jargon Buster

Couplings are often referred to as either "females" or "sockets" or "couplers".

Adaptors are also known as "males" or "plugs" or "nipples".

Nominal bore is the term used for the internal diameter of the hole that runs through the length of the adaptor.



Couplings & Adaptors

STANDARD RANGE

SAFEFLOW SERIES

Safeflow takes PCL's industry-proven, quick release Airflow Coupling to the next level - offering a two-stage self-venting release which completely eliminates the dangers of hose whip. Pneumatic equipment and tools can be disconnected safely, making Safeflow suitable for all compressed air applications.

Features

- Two-stage self venting release
- Steel construction
- Corrosive resistant finish
- Designed and manufactured in Sheffield, England
- Conforms to safety standards ISO 1998:4414 & EN 983:1996



Part Number Thread Type Thread Size

Safeflow Coupling		
SC21CM	Male	R 1/4
SC21EM	Male	R 3/8
SC21JM	Male	R 1/2
SC21CF	Female	Rp 1/4
SC21EF	Female	Rp 3/8
SC21JF	Female	Rp 1/2
SC21R	Hose Tailpiece	7 mm / 1/4 in
SC21S	Hose Tailpiece	8 mm / 5/16 in
SC21T	Hose Tailpiece	10 mm / 3/8 in

- Nominal bore: 4.8 mm
- Flow rate: 43 cfm @ 100 psi
- Maximum working pressure: 14 bar / 200 psi
- Temperature range: -40°C to 100°C

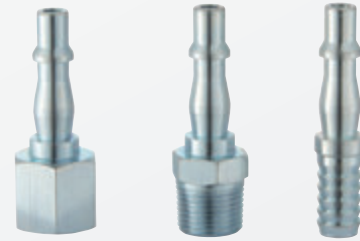

Part Number Thread Type Thread Size

Standard Adaptors		
ACA2593	Male	R 1/4
ACA6909	Male	R 3/8
ACA6584	Male	R 1/2
ACA2746	Female	Rp 1/4
ACA6582	Female	Rp 3/8
ACA6583	Female	Rp 1/2
ACA2486	Hose Tailpiece	4.75 mm / 3/16 in
ACA1793	Hose Tailpiece	6.35 mm / 1/4 in
ACA2487	Hose Tailpiece	7.9 mm / 5/16 in
ACA2488	Hose Tailpiece	9.5 mm / 3/8 in
ACA9438	Hose Tailpiece	13 mm / 1/2 in

INTERCHANGEABLE » RECTUS 19

WHAT DOES THE PCL BLUE BAND MEAN?

PCL's core lines of couplings - Vertex, XF-Euro and Airflow - are now being manufactured with a distinctive blue silicone band to define them as genuine "Made in Sheffield" products. Significant investment has resulted in an immediately recognisable, even higher quality fitting, meaning customers can feel safe in the knowledge that if it has the blue band it's a true PCL brand, made to our exacting standards, and carries a 5-year warranty.



Hose

Hose Fittings

Tyre Inflation Equipment

Tyre Care

Nitrogen Equipment

Workshop Equipment

Air Tools

Air Tool Accessories



STANDARD RANGE

NON-CORRODIBLE SERIES

This non-corrodible, brass range is designed and manufactured by PCL for specialist applications such as breathing air, non-spark, damp or high condensation environments and can be used outdoors.



Part Number	Thread Type	Thread Size
Non-Corrodible Couplings		
AC32CM	Male	R 1/4
AC32CF	Female	Rp 1/4

- Nominal bore: 4.8 mm
- Flow rate: 43 cfm @ 100 psi
- Maximum working pressure: 14 bar / 200 psi
- Temperature range: -40°C to 100°C

INTERCHANGEABLE » RECTUS 19

Features

- All brass body coupling and valve with phosphor bronze balls
- For use in breathing air applications, non spark, damp or high condensation environments and can be used outdoors
- Positive locking mechanism

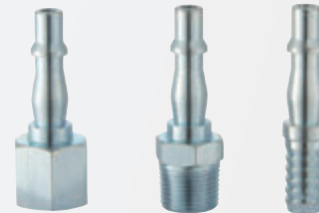

Part Number	Thread Type	Thread Size
Standard Adaptors		
ACA2593	Male	R 1/4
ACA6909	Male	R 3/8
ACA6584	Male	R 1/2
ACA2746	Female	Rp 1/4
ACA6582	Female	Rp 3/8
ACA6583	Female	Rp 1/2
ACA2486	Hose Tailpiece	4.75 mm / 3/16 in
ACA1793	Hose Tailpiece	6.35 mm / 1/4 in
ACA2487	Hose Tailpiece	7.9 mm / 5/16 in
ACA2488	Hose Tailpiece	9.5 mm / 3/8 in
ACA9438	Hose Tailpiece	13 mm / 1/2 in

HOW TO MEASURE A PIPE THREAD

Thread sizes are based on tradé size rather than actual dimension, which often leads to confusion. Here is our simple guide to measuring a thread and identifying it as a British Standard Pipe (BSP).

The BSP is the UK's most commonly used type of thread and falls into two categories:

- **Parallel (BSPP)** - also known as G or Rp
- **Tapered (BSPT)** - also known as R or Rc

R, Rp and Rc threads are taken from BS21:1985 pipe threads for tubes and fittings where pressure-tight joints are made on the threads. Meanwhile G threads are taken from BS2779:1986 pipe threads for tubes and fittings where pressure-tight joints are usually made on a washer or 'O' ring.

Using a ruler or Vernier, measure across the outside diameter of a male thread. If the thread measures 0.5" it is not a 1/2" BSP thread.

Using the table below you can see that a measurement of 0.5" is actually a 1/4" BSP thread and that a 0.75" measurement is a 1/2" BSP thread. So, you can basically take 0.25" off your measurement to get the corresponding BSP thread.

Trade Size (BSP)	Threads per inch (TPI)	Max Diameter		Min Diameter	
		inch	mm	inch	mm
1/8	28	0.383	9.728	0.3372	8.565
1/4	19	0.518	13.157	0.4506	11.445
3/8	19	0.656	16.662	0.5886	14.95
1/2	14	0.825	20.955	0.7336	18.633
3/4	14	1.041	26.441	0.9496	24.12
1	11	1.309	33.249	1.1926	30.292

For more helpful product advice, visit www.pclairtechnology.com/support



Couplings & Adaptors

HIGH FLOW RANGE

XF-EURO SERIES

Commonly referred to as Euro Couplings, the XF-Euro series boasts excellent flow characteristics, providing the workshop with increased airflow when required, giving enhanced tool efficiency.

Features

- High flow rate of 130 cfm @ 100 psi
- Hardened steel construction with corrosive resistant finish
- Steel shoulder helps prevent accidental disconnection
- Enhances tool efficiency

INTERCHANGEABLE »
 CEJN 320
 LEGRIS 25/26
 NORGRN 234/238
 RECTUS 25/26
 SCHRADER INTERCHECK 35



Part Number	Thread Type	Thread Size
XF-Euro Couplings		
AC71CM	Male	R 1/4
AC71EM	Male	R 3/8
AC71JM	Male	R 1/2
AC71CF	Female	Rp 1/4
AC71EF	Female	Rp 3/8
AC71JF	Female	Rp 1/2
AC7106	Hose Tailpiece	6 mm
AC7108	Hose Tailpiece	8 mm
AC7109	Hose Tailpiece	9 mm
AC7110	Hose Tailpiece	10 mm
AC7113	Hose Tailpiece	13 mm

Part Number	Thread Type	Thread Size
XF-Euro Adaptors		
AA7101	Male	R 1/8
AA7102	Male	R 1/4
AA7103	Male	R 3/8
AA7104	Male	R 1/2
AA7105	Female	Rp 1/8
AA7106	Female	Rp 1/4
AA7107	Female	Rp 3/8
AA7108	Female	Rp 1/2
AA7109	Hose Tailpiece	4 mm
AA7110	Hose Tailpiece	6 mm
AA7111	Hose Tailpiece	8 mm
AA7114	Hose Tailpiece	9 mm
AA7112	Hose Tailpiece	10 mm
AA7113	Hose Tailpiece	13 mm
XF-Euro Safety Adaptors		
AA7103/STY	Male	R 3/8

- Nominal bore: 7.4 mm
- Flow rate @ 6 bar (0.5 bar p.d.): 2,200 l/min
- Maximum working pressure: 35 bar / 508 psi
- Temperature range: -40°C to 100°C

Hose

Hose Fittings

Tyre Inflation Equipment

Tyre Care

Nitrogen Equipment

Workshop Equipment

Air Tools

Air Tool Accessories



HIGH FLOW RANGE

XF-EURO SAFETY SERIES

PCL's XF-Euro Safety Couplings are designed to conform to compressed air Health & Safety Guide HS(G)39 and are simple to use, facilitating a safe environment.

See also ISO 4414:2010 for safety requirements covering the installation and use of pneumatic equipment.

Features

- Two stage self-venting release
- Creates a safe compressed air environment
- Safe and simple to use
- Best practice for compressed air users
- Enhances workshop safety - prevents hose whip

INTERCHANGEABLE »
CEJN 320
LEGRIS 25/26
NORGREN 234/238
RECTUS 25/26
SCHRADER INTERCHECK 35



Part Number	Thread Type	Thread Size
XF-Euro Safety Couplings		
AS71CM	Male	R 1/4
AS71EM	Male	R 3/8
AS71JM	Male	R 1/2
AS71CF	Female	R 1/4
AS71EF	Female	R 3/8
AS71JF	Female	R 1/2

Part Number	Thread Type	Thread Size
XF-Euro Adaptors		
AA7101	Male	R 1/8
AA7102	Male	R 1/4
AA7103	Male	R 3/8
AA7104	Male	R 1/2
AA7105	Female	Rp 1/8
AA7106	Female	Rp 1/4
AA7107	Female	Rp 3/8
AA7108	Female	Rp 1/2
AA7109	Hose Tailpiece	4 mm
AA7110	Hose Tailpiece	6 mm
AA7111	Hose Tailpiece	8 mm
AA7114	Hose Tailpiece	9 mm
AA7112	Hose Tailpiece	10 mm
AA7113	Hose Tailpiece	13 mm

- Nominal bore: 7.4 mm
- Flow rate @ 6 bar supply: 1,750 l/min @ 0.5 bar p.d.
- Maximum working pressure: 200 psi / 16 bar

Explore our new ERGO and ERGO EXTREME Blowguns



See pages 78-79

Couplings & Adaptors

Hose

Hose Fittings

Tyre Inflation Equipment

Tyre Care

Nitrogen Equipment

Workshop Equipment

Air Tools

Air Tool Accessories



Couplings & Adaptors

COUPLING & ADAPTOR KITS

EMERGENCY COUPLING KITS

Designed to keep in the workshop in case of a pneumatic air line failure, PCL's compact emergency kit contains all the parts a service engineer might need to repair any standard air line failure.

Features

- Includes couplings, adaptors, hose tails, hose connectors, hose clips and PTFE tape to convert or repair an air line connection,
- Solid 'pocket' case with item part numbers and descriptions on the underside,
- Ideal to keep in a van or workshop



Part Number	Description	Kit Contents
ACKIT01	Emergency Vertex Series kit	x 1: AC91CM, AC91CF, HC6560, HC6892, HC6893, HC5656, HC1217, HC2479, HC6895, HC6896 & PTFE tape x 2: ACA2593, ACA2746, 00 & 000 Jubilee Clips
ACKIT02	Emergency XF-Euro Series kit	x 1: AC71CM, AC71CF, HC5656, HC6560, HC6892, HC1217, HC6895, HC6893, HC2479, HC6896 & PTFE tape x 2: AA7102, AA7106, 00 & 000 Jubilee Clips

Hose

Hose Fittings

Tyre Inflation Equipment

GARAGE WORKSHOP RANGE

100 SERIES

This traditional "Made in Sheffield" coupling range is designed and manufactured by PCL to offer greater airflow characteristics for larger air tool applications in heavy duty garage, tyre shop and industrial environments.

Features

- Hardened shoulder helps prevent accidental disconnection
- Specially designed valves and large aperture adaptors provide increased airflow for heavy duty applications
- Swivel feature prevents kinking of the hose

Tyre Care



Nitrogen Equipment

Workshop Equipment

Part Number	Thread Type	Thread Size
100 Series Couplings		
AC5EM	Male	R 3/8
AC5JM	Male	R 1/2
AC5EF	Female	Rp 3/8
AC5JF	Female	Rp 1/2

Part Number	Thread Type	Thread Size
100 Series Adaptors		
ACA2999	Male	R 3/8
ACA3035	Male	R 1/2
ACA2994	Female	Rp 3/8
ACA3037	Hose Tailpiece	9.5 mm / 3/8 in
ACA3036	Hose Tailpiece	12.7 mm / 1/2 in
100 Series Safety Adaptors		
ACA9301	Male	R 1/2

- Nominal bore: 10.3 mm
- Flow rate: 117 cfm @ 100 psi
- Maximum working pressure: 14 bar / 200 psi
- Temperature range: -40°C to 100°C

Air Tools

Air Tool Accessories



GARAGE WORKSHOP RANGE

60 SERIES

This traditional "Made in Sheffield" coupling range is designed and manufactured by PCL and are ideal for fixed and trailing hose applications in garage, tyre shop and industrial environments.



Part Number Thread Type Thread Size

60 Series Couplings		
AC4CM	Male	R 1/4
AC4EM	Male	R 3/8
AC4JM	Male	R 1/2
AC4CF	Female	Rp 1/4
AC4EF	Female	Rp 3/8
AC4JF	Female	Rp 1/2

- Nominal bore: 7.1 mm
- Flow rate: 60 cfm @ 100 psi
- Maximum working pressure: 14 bar / 200 psi
- Temperature range: -40°C to 100°C

Features

- Hardened shoulder helps prevent accidental disconnection
- Swivel feature prevents kinking of the hose

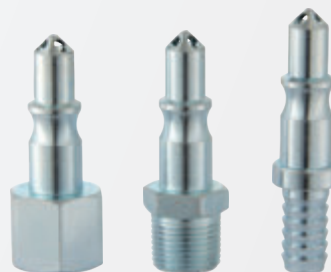

Part Number Thread Type Thread Size

60 Series Adaptors		
ACA2657	Male	R 1/4
ACA2661	Male	R 3/8
ACA2653	Female	Rp 1/4
ACA2660	Female	Rp 3/8
ACA2654	Hose Tailpiece	7.9 mm / 5/16 in
ACA2658	Hose Tailpiece	9.5 mm / 3/8 in
ACA2659	Hose Tailpiece	12.7 mm / 1/2 in
60 Series Safety Adaptors		
ACA9201	Male	R 3/8

BAYONET RANGE

1/2" INSTANTAIR SERIES

These InstantAir 1/2" Couplings are made in Sheffield to PCL's high quality and standards. Offering higher flow characteristics, they are ideal for heavy duty industrial applications.

Features

- Bayonet type couplings
- Not interchangeable with standard InstantAir range



Part Number Broomwade Reference Thread Type Thread Size

1/2" InstantAir Couplings			
AC59JM	PT8811	Male	R 1/2
AC59JF	PT8812	Female	Rp 1/2
AC59V	PT8813	Hose Tailpiece	12.7 mm / 1/2 in

- Nominal bore: 8.0 mm
- Maximum flow rate: 70 cfm @ 100 psi
- Maximum working pressure: 17 bar / 250 psi
- Maximum vacuum: 660 mm / 26 in Hg



Part Number Broomwade Reference Thread Type Thread Size

1/2" InstantAir Adaptors			
AA5904	PT8825	Male	R 1/2
AA5908	PT8827	Female	Rp 1/2
AA5913	PT9095	Hose Tailpiece	12.7 mm / 1/2 in

Couplings & Adaptors

Hose

Hose Fittings

Tyre Inflation Equipment

Tyre Care

Nitrogen Equipment

Workshop Equipment

Air Tools

Air Tool Accessories



BAYONET RANGE

INSTANTAIR SERIES

PCL's "Made in Sheffield" bayonet type, quick acting couplings feature a positive seal, and are designed for maximum efficiency and to prevent accidental uncoupling.

Features

- Bayonet type couplings
- Zinc plated steel / Brass chrome plated
- High temperature version also available



- Nominal bore: 5.6 mm
- Flow rate: 54 cfm @ 100 psi
- Maximum working pressure: 17 bar / 250 psi
- Temperature range: -20°C to 80°C
- Suitable for use with: InstantAir Adaptors



Part Number	Broomwade Reference	Thread Type	Thread Size
InstantAir Couplings			
AC51CM	PT8825	Male	G 1/4
AC51EM	PT8827	Male	G 3/8
AC51JM	PT9095	Male	R 1/2
AC51CF	PT8823	Female	Rp 1/4
AC51EF	PT8800	Female	Rp 3/8
AC51JF	PT9096	Female	Rp 1/2
AC51R	PT8800/SU4	Hose Tailpiece	6.35 mm / 1/4 in
AC51S	PT8800/SU5	Hose Tailpiece	7.9 mm / 5/16 in
AC51T	PT8800/SU6	Hose Tailpiece	9.5 mm / 3/8 in
Brass Chrome Plated InstantAir Couplings			
AC52CM	PT8826	Male	R 1/4
AC52CF	PT8824	Female	Rp 1/4

Part Number	Broomwade Reference	Thread Type	Thread Size
InstantAir Adaptors			
AA5102	PT8808	Male	G 1/4
AA5103	PT8817	Male	G 3/8
AA5106	PT8806	Female	Rp 1/4
AA5107	PT8802	Female	Rp 3/8
AA5110	PT8802/SU4	Hose Tailpiece	6.35 mm / 1/4 in
AA5111	PT8802/SU5	Hose Tailpiece	7.9 mm / 5/16 in
AA5112	PT8802/SU6	Hose Tailpiece	9.5 mm / 3/8 in
InstantAir Safety Adaptors			
AA5103/STY		Male	R 3/8
Brass Chrome Plated InstantAir Adaptors			
AA5202	PT8809	Male	R 1/4

INSTANTAIR SERIES

PCL's InstantAir Swivel Adaptors are suitable for most fixed compressed air applications, although swivel adaptors are recommended for trailing hose applications.



Part Number	Broomwade Reference	Thread Type	Thread Size
-------------	---------------------	-------------	-------------

InstantAir Swivel Adaptors			
AA5302	PT8836	Male	G 1/4
AA5303	PT8838	Male	G 3/8
AA5306	PT8834	Female	Rp 1/4
AA5307	PT8804	Female	Rp 3/8
AA5310	PT8804/SU4	Hose Tailpiece	6.35 mm / 1/4 in
AA5311	PT8804/SU5	Hose Tailpiece	7.9 mm / 5/16 in
AA5312	PT8804/SU6	Hose Tailpiece	9.5 mm / 3/8 in
Brass Chrome Plated InstantAir Swivel Adaptors			
AA5402	PT8837	Male	R 1/4

- Maximum working pressure - Under continuous rotation: 10 bar
- Maximum working pressure - Static and random rotation: 17 bar



TWIST LOCK RANGE

STANDARD SCHRADER SERIES

Comprising Schrader Couplings (manufactured by Parker Pneumatics) and compatible adaptors, this series is suitable for larger volume compressed air applications.

Features

- Twist locking feature
- Adaptor can swivel when coupled, eliminating hose kinks

INTERCHANGEABLE »
CEJN 399
RECTUS 17



Part Number Schrader Reference Thread Type Thread Size

Standard Schrader Couplings			
ACS102	9793D-12	Male	R 1/4
ACS103	9792D-12	Male	R 3/8
ACS101	8952DL-12	Female	Rp 1/4
Standard Schrader Compatible Adaptors			
ACAS104	8050B-11	Male	R 1/4
ACAS105	8278L-11	Female	Rp 1/4
ACAS101	8787-11	Hose Tailpiece	6 mm / 1/4 in
ACAS103	9750-11	Hose Tailpiece	8 mm / 5/16 in
ACAS102	8788-11	Hose Tailpiece	10 mm / 3/8 in

- Nominal bore: 5.0 mm
- Flow rate @ 6 bar (0.5 bar p.d.): 900 l/min
- Maximum working pressure: 17 bar / 250 psi
- Temperature range: -20°C to 80°C

HEAVY DUTY SCHRADER SERIES

Heavy Duty Schrader Couplings (manufactured by Parker Pneumatics) with compatible adaptors are generally suitable for most fixed compressed air applications.

Features

- Twist locking feature
- Adaptor can swivel when coupled, eliminating hose kinks

INTERCHANGEABLE »
CEJN 499
RECTUS 68



Part Number Schrader Reference Thread Type Thread Size

Heavy Duty Schrader Couplings			
ACS202	1054EL-12	Female	Rp 1/4
ACS203	1095EL-12	Female	Rp 3/8
ACS201	1461EL-12	Female	Rp 1/2
Heavy Duty Schrader Compatible Adaptors			
ACAS204	8624B-11	Male	R 1/4
ACAS205	9739-11	Male	R 3/8
ACAS203	8807-11	Male	R 1/2
ACAS206	1261L-11	Female	Rp 1/4
ACAS207	1096B-11	Female	Rp 3/8
ACAS201	1097-11	Hose Tailpiece	10 mm / 3/8 in
ACAS202	1098-11	Hose Tailpiece	12 mm / 1/2 in

- Nominal bore: 8.5 mm
- Flow rate @ 6 bar (0.5 bar p.d.): 500 l/min
- Maximum working pressure: 17 bar / 250 psi
- Temperature range: -20°C to 80°C

Explore our range of hoses



See pages 22-29

Couplings & Adaptors

Hose

Hose Fittings

Tyre Inflation Equipment

Tyre Care

Nitrogen Equipment

Workshop Equipment

Air Tools

Air Tool Accessories



INTERCHANGE RANGE

MINI SERIES

Specially designed for light engineering environments, PCL's range of small-bore couplings has proved popular in the robotics, medical, instrumentation and automation industries.

Features

- Manufactured in brass with chrome plate finish
- Lightweight and compact design
- Single action / one handed operation



INTERCHANGEABLE »
CAMOZZI MINI
LEGRIS 21
NORGREN 233
RECTUS 21
SCHRADER MINI



Part Number	Thread Type	Thread Size
Mini Couplings		
AC11AM	Male	R 1/8
AC11CM	Male	R 1/4
AC11BHAM	Male Bulkhead Fixing	R 1/8
AC11BHCM	Male Bulkhead Fixing	R 1/4
AC11AF	Female	Rp 1/8
AC11CF	Female	Rp 1/4
AC11RF6/4	Tube Connector	6 mm OD - 4 mm ID
AC11RF8/6	Tube Connector	8 mm OD - 6 mm ID
AC11BH6/4	Tube Connector Bulkhead Fixing	6 mm OD - 4 mm ID
AC11BH8/6	Tube Connector Bulkhead Fixing	8 mm OD - 6 mm ID
AC1106	Hose Tailpiece	6 mm
AC1108	Hose Tailpiece	8 mm
AC1109	Hose Tailpiece	9 mm
AC11AK6/4	Tube Connector Anti-kink	6 mm OD - 4 mm ID
AC11AK8/6	Tube Connector Anti-kink	8 mm OD - 6 mm ID

Part Number	Thread Type	Thread Size
Mini Adaptors		
AA11AM	Male	R 1/8
AA11CM	Male	R 1/4
AA11AF	Female	Rp 1/8
AA11CF	Female	Rp 1/4
AA11RF6/4	Tube Connector	6 mm OD - 4 mm ID
AA11RF8/6	Tube Connector	8 mm OD - 6 mm ID
AA1104	Hose Tailpiece	4 mm
AA1106	Hose Tailpiece	6 mm
AA1109	Hose Tailpiece	9 mm
AA11AK6/4	Tube Connector Anti-kink	6 mm OD - 4 mm ID
AA11AK8/6	Tube Connector Anti-kink	8 mm OD - 6 mm ID

- Nominal bore: 5.0 mm
- Flow rate @ 6 bar (0.5 bar p.d.): 560 l/min
- Maximum working pressure: 35 bar / 508 psi
- Temperature range: -20°C to 80°C

Explore our push-in fittings range in the hose fittings section



See page 37



INTERCHANGE RANGE

A STYLE SERIES

Designed and developed by PCL for most general air applications, commonly used in American and most African markets where this specific profile of adaptor is required.

Features

- Robust slimline construction
- Single action connection
- Steel construction with corrosive resistant finish



INTERCHANGEABLE »
 ARO 210
 CEJN 300
 JWL 522/532
 RECTUS 14/22
 SCHRADER EURO

Part Number Thread Type Thread Size

A Style Couplings		
AC61CM	Male	R 1/4
AC61EM	Male	R 3/8
AC61JM	Male	R 1/2
AC61CF	Male	RP 1/4
AC61EF	Male	Rp 3/8
AC61JF	Male	Rp 1/2
AC61R	Hose Tailpiece	7 mm
AC61S	Hose Tailpiece	8 mm
AC61T	Hose Tailpiece	10 mm
A Style Adaptors		
ACA6923	Male	R 1/4
ACA6924	Female	Rp 1/4
ACA6912	Hose Tailpiece	6.35 mm / 1/4 in
ACA6922	Hose Tailpiece	7.9 mm / 5/16 in
ACA6930	Hose Tailpiece	9.5 mm / 3/8 in

- Nominal bore: 5.5 mm
- Flow rate @ 6 bar (0.5 bar p.d.): 650 l/min
- Maximum working pressure: 14 bar / 200 psi
- Temperature range: -40°C to 100°C

PF SERIES

PCL has designed and manufactured the quick release PF Series of couplings as a competitive alternative to the genuine Schrader range.

Features

- Competitive alternative to Schrader Couplings and Adaptors
- Lightweight construction
- Superior flow characteristics
- Corrosive resistant finish



INTERCHANGEABLE »
 CEJN 399
 RECTUS 17
 STANDARD SCHRADER

Part Number Thread Type Thread Size

PF Couplings		
AC77CM	Male	R 1/4
AC77EM	Male	R 3/8
AC77JM	Male	R 1/2
AC77CF	Female	Rp 1/4
AC77EF	Female	Rp 3/8
AC77JF	Female	Rp 1/2
AC7706	Hose Tailpiece	6 mm
AC7708	Hose Tailpiece	8 mm
AC7710	Hose Tailpiece	10 mm
AC7713	Hose Tailpiece	13 mm
PF Adaptors		
AA7702	Male	R 1/4
AA7703	Male	R 3/8
AA7706	Female	Rp 1/4
AA7707	Female	Rp 3/8
AA7710	Hose Tailpiece	6 mm
AA7711	Hose Tailpiece	8 mm
AA7712	Hose Tailpiece	10 mm

- Nominal bore: 5.0 mm
- Flow rate @ 6 bar (0.5 bar p.d.): 2,200 l/min
- Temperature range: -40°C to 100°C
- Maximum working pressure: 35 bar / 508 psi

Couplings & Adaptors

Hose

Hose Fittings

Tyre Inflation Equipment

Tyre Care

Nitrogen Equipment

Workshop Equipment

Air Tools

Air Tool Accessories



INTERCHANGE RANGE

ISO B12 SERIES

PCL's "Made in Sheffield" ISO B12 couplings offer excellent flow characteristics for industrial applications, commonly used in Scandinavian markets, where this adaptor profile is required.

Features

- Offers enhanced tool efficiency
- Steel construction with corrosive resistant finish
- Steel shoulder helps prevent accidental disconnection
- Offers excellent flow characteristics



INTERCHANGEABLE »
CEJN 310
HANSON 3000
LEGRIS 24
RECTUS 23/24

Part Number Thread Type Thread Size

ISO B12 Couplings		
AC75CM	Male	R 1/4
AC75EM	Male	R 3/8
AC75JM	Male	R 1/2
AC75CF	Female	Rp 1/4
AC75EF	Female	Rp 3/8
AC75JF	Female	Rp 1/2
AC7506	Hose Tailpiece	6 mm
AC7508	Hose Tailpiece	8 mm
AC7510	Hose Tailpiece	10 mm
AC7513	Hose Tailpiece	13 mm
ISO B12 Adaptors		
AA7502	Male	R 1/4
AA7503	Male	R 3/8
AA7504	Male	R 1/2
AA7506	Female	Rp 1/4
AA7507	Female	Rp 3/8
AA7510	Hose Tailpiece	6 mm
AA7511	Hose Tailpiece	8 mm
AA7512	Hose Tailpiece	10 mm
AA7513	Hose Tailpiece	13 mm

- Nominal bore: 5.5 mm
- Flow rate @ 6 bar (0.5 bar p.d.): 1,100 l/min
- Maximum working pressure: 35 bar / 508 psi
- Temperature range: -40°C to 100°C

KF SERIES

PCL's KF Series is ideal for portable air tool and industrial applications, offering excellent flow characteristics, commonly used in Asian and Oceania markets where this adaptor profile is required.

Features

- Offers enhanced tool efficiency
- Steel construction with corrosive resistant finish
- Steel shoulder helps prevent accidental disconnection
- Offers excellent flow characteristics



INTERCHANGEABLE »
CEJN 315
NITTO KOHKI 200
RECTUS 13

Part Number Thread Type Thread Size

KF Couplings		
AC78CM	Male	R 1/4
AC78EM	Male	R 3/8
AC78JM	Male	R 1/2
AC78CF	Female	Rp 1/4
AC78EF	Female	Rp 3/8
AC78JF	Female	Rp 1/2
AC7806	Hose Tailpiece	6 mm
AC7808	Hose Tailpiece	8 mm
AC7810	Hose Tailpiece	10 mm
AC7813	Hose Tailpiece	13 mm
KF Adaptors		
AA7802	Male	R 1/4
AA7803	Male	R 3/8
AA7804	Male	R 1/2
AA7806	Female	Rp 1/4
AA7807	Female	Rp 3/8
AA7808	Female	Rp 1/2
AA7810	Hose Tailpiece	6 mm
AA7811	Hose Tailpiece	8 mm
AA7812	Hose Tailpiece	10 mm
AA7813	Hose Tailpiece	13 mm

- Nominal bore: 7.6 mm
- Flow rate @ 6 bar (0.5 bar p.d.): 2,100 l/min
- Maximum working pressure: 35 bar / 508 psi
- Temperature range: -40°C to 100°C

Couplings & Adaptors

Hose

Hose Fittings

Tyre Inflation Equipment

Tyre Care

Nitrogen Equipment

Workshop Equipment

Air Tools

Air Tool Accessories



ACTUAL SIZE ADAPTOR PROFILES

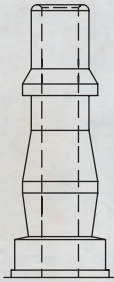

STANDARD RANGE

The adaptor profiles displayed are actual size - just place your adaptor on the matching drawing to find its interchange.

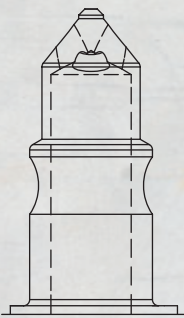

100 SERIES

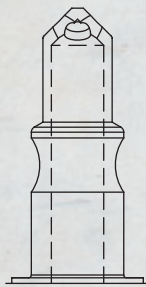

60 SERIES

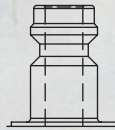

MINI RANGE

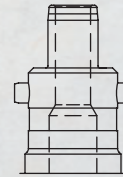

INSTANTAIR RANGE

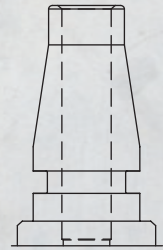

HEAVY DUTY SCHRADER

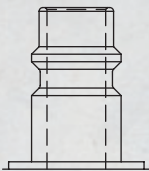

XF RANGE

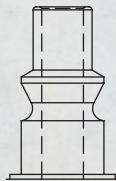

EURO RANGE

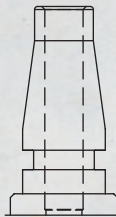

PF RANGE

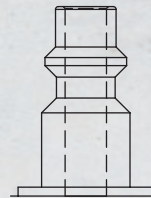

ISO B12 RANGE

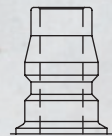

KF RANGE

ACTUAL SIZE THREADFORM PROFILES

Male thread profiles, displayed as actual size - just place your thread on the matching drawing to find its size.

R, Rp, Rc threads are taken from BS21:1985 pipe threads for tubes and fittings where pressure tight joints are made on the threads.

G threads are taken from BS2779:1986 pipe threads for tubes and fittings where pressure tight joints are not made on the threads.

R 1/8 MALE THREAD

R 1/4 MALE THREAD

R 3/8 MALE THREAD

R 1/2 MALE THREAD



Couplings & Adaptors

Hose

Hose Fittings

Tyre Inflation Equipment

Tyre Care

Nitrogen Equipment

Workshop Equipment

Air Tools

Air Tool Accessories

HOSE

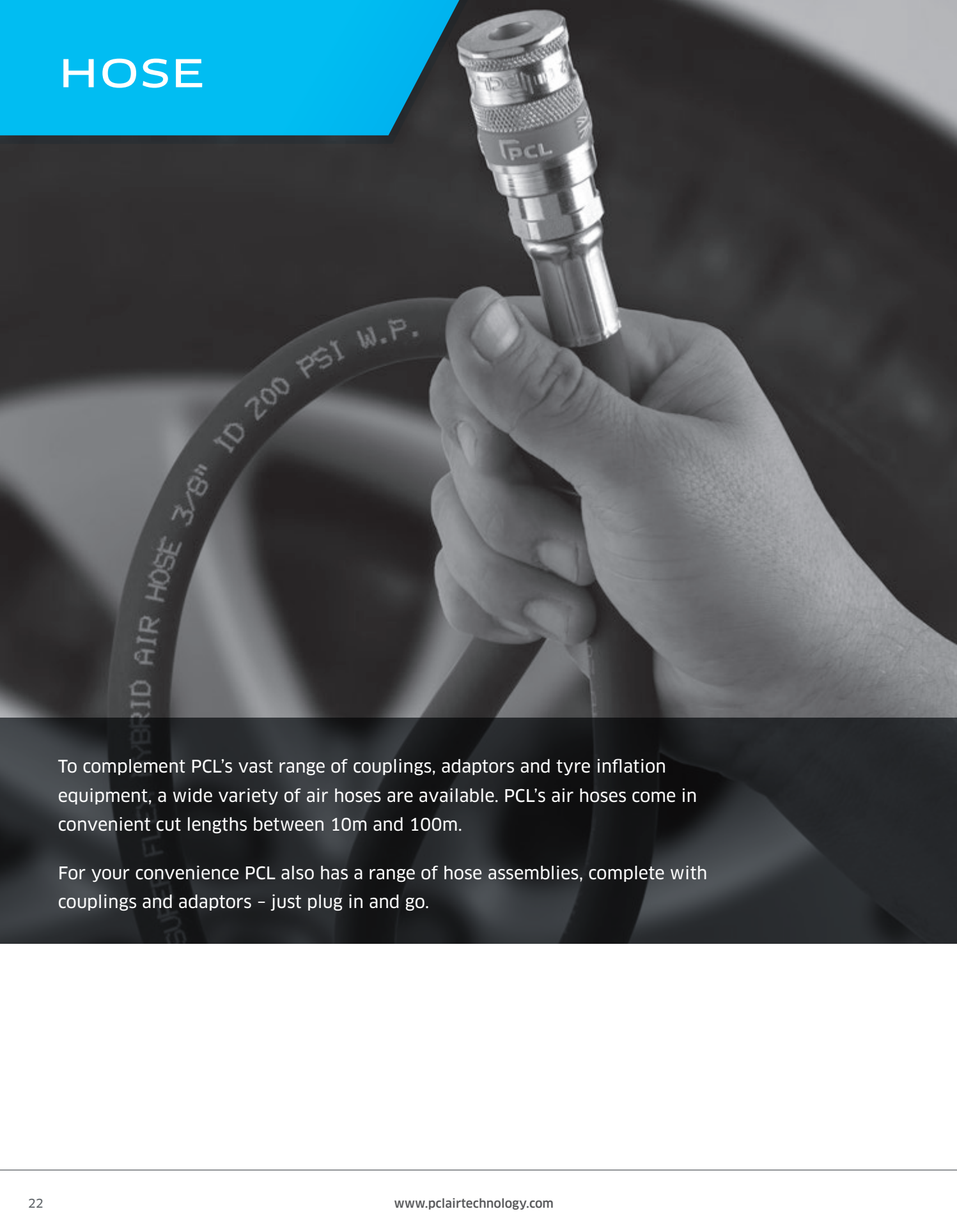

To complement PCL's vast range of couplings, adaptors and tyre inflation equipment, a wide variety of air hoses are available. PCL's air hoses come in convenient cut lengths between 10m and 100m.

For your convenience PCL also has a range of hose assemblies, complete with couplings and adaptors - just plug in and go.

BEST SELLER

SUPERFLEX HOSE ASSEMBLIES



SUPERFLEX HOSE
with No End Fittings



SUPERFLEX HOSE
with XF-Euro Fittings



SUPERFLEX HOSE
with Rp 1/4 Swivel End
Fittings



SUPERFLEX HOSE
with Standard Adaptor
and Vertex Coupling
Fittings

See range on page 24

Hose



Air Hose

Page 25



Nylon Tubing

Page 25



**Air Hoses with Swivel
End Fittings**

Page 26



**High Visibility Air Hose
Assemblies**

Page 26



Air Tool Hose Assemblies

Page 27



Air Tool Whip Hoses

Page 28



**Polyurethane Coiled Air
Hose Assemblies**

Page 29



**Nylon Coiled Air Hose
Assemblies**

Page 29



Couplings & Adaptors

Hose

Hose Fittings

Tyre Inflation Equipment

Tyre Care

Nitrogen Equipment

Workshop Equipment

Air Tools

Air Tool Accessories

SUPERFLEX HOSE ASSEMBLIES

SUPERFLEX HOSE ASSEMBLIES

BEST SELLER

PCL's new 9.5mm (3/8") SuperFlex hose is designed to be extremely flexible and hard-wearing. Highly resistant to ultra-violet and a wide range of acids and alkalis, SuperFlex assemblies provide longer service life and are suitable for a wider range of applications.

In addition, the SuperFlex features anti-kink characteristics, with elimination of hose kinks resulting in minimum air flow loss.

Features

- Soft touch for excellent handling - Increased comfort for the user
- Extremely flexible with good anti-kink characteristics - Minimum air flow loss
- Durable with excellent ageing and ultra-violet resistance - Increased service life
- Highly resistant to a wide range of acids and alkalis - Suitable for a wide range of applications

- Working pressure: 14 bar / 200 psi
- Burst pressure: 42 bar / 600 psi (3:1 safety factor)
- Temperature range: -15°C + 60°C

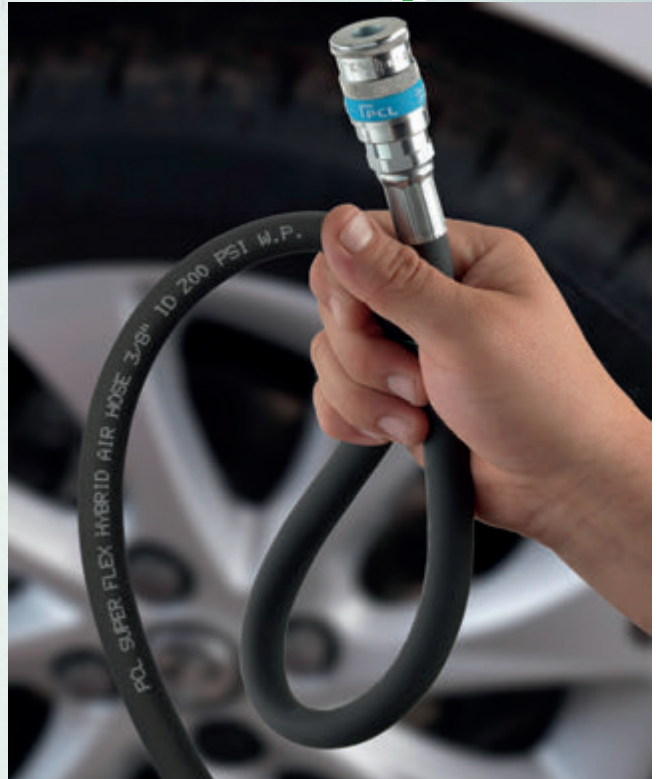

SUPERFLEX HOSE with No End Fittings

Part Number	Hose Length (m)	Inside Diameter (mm)
HS25B01SF	5	9.5
HS25C01SF	10	9.5
HS25D01SF	15	9.5
HS25E01SF	20	9.5
HS25X01SF	100	9.5



SUPERFLEX HOSE with XF-Euro Fittings

Part Number	Hose Length (m)	Inside Diameter (mm)
HA2140SF	5	9.5
HA2141SF	10	9.5
HA2142SF	15	9.5
HA2143SF	20	9.5



SUPERFLEX HOSE with Rp 1/4 Swivel End Fittings

Part Number	Hose Length (m)	Inside Diameter (mm)
HA2043SF	5	9.5
HA2044SF	10	9.5
HA2045SF	15	9.5
HA2046SF	20	9.5



SUPERFLEX HOSE with Standard Adaptor and Vertex Coupling Fittings

Part Number	Hose Length (m)	Inside Diameter (mm)
HA2133SF	5	9.5
HA2134SF	10	9.5
HA2139SF	15	9.5
HA2129SF	20	9.5





AIR HOSE

AIR HOSE

PCL's air hose is made from a high-performance TPE compound, meaning it looks and feels like rubber but doesn't have its associated downsides.

Available in various cut lengths from 10m to 100m, it can also be ordered cut to the precise length required to reduce waste.

Features

- Excellent abrasion resistance
- Good flexibility and kink resistant
- Silicone free



Part Number	Inside Diameter	Outside Diameter (mm)	Hose Length (m)
HS22C01	7 mm / 1/4 in	14	10
HS22D01	7 mm / 1/4 in	14	15
HS22E01	7 mm / 1/4 in	14	20
HS22H01	7 mm / 1/4 in	14	30
HS22X01	7 mm / 1/4 in	14	100
HS24C01	8 mm / 5/16 in	15	10
HS24D01	8 mm / 5/16 in	15	15
HS24E01	8 mm / 5/16 in	15	20
HS24H01	8 mm / 5/16 in	15	30
HS24X01	8 mm / 5/16 in	15	100
HS25C01	10 mm / 3/8 in	17	10
HS25D01	10 mm / 3/8 in	17	15
HS25E01	10 mm / 3/8 in	17	20
HS25H01	10 mm / 3/8 in	17	30
HS25X01	10 mm / 3/8 in	17	100
HS27C01	13 mm / 1/2 in	21	10
HS27D01	13 mm / 1/2 in	21	15
HS27E01	13 mm / 1/2 in	21	20
HS27H01	13 mm / 1/2 in	21	30
HS27X01	13 mm / 1/2 in	21	100

- Working pressure: 21 bar / 300 psi
- Burst pressure: 63 bar / 900 psi (3:1 safety factor)
- Temperature range: -15°C to 60°C

Please note - an increase in temperature above 20°C will affect the working pressure quoted above

NYLON TUBING

Manufactured from high quality nylon granules, this tubing is ideal for use with push-in fittings and for a wide range of industrial applications, including: compressed air, lubrication, refrigeration, air conditioning, coolant lines, fuels and oils.

Features

- Available in 3 colours: Natural, Black and Blue
- Supplied in 30m coils



Part Number	Inside Diameter (mm)	Outside Diameter (mm)	Working Pressure	Bend Radius (mm)
TRN-4/2.5-*	2.5	4	400 psi / 27 bar	16
TRN-6/4-*	4	6	350 psi / 24 bar	35
TRN-8/6-*	6	8	255 psi / 17 bar	60
TRN-10/8-*	8	10	200 psi / 14 bar	100
TRN-12/10-*	10	12	160 psi / 11 bar	125

When ordering replace * in the part number with your colour choice. If no colour choice is specified, Natural will be supplied as standard.

Please note - values stated are based on the short term burst pressure of nylon at 20°C using a 4:1 safety factor

- Material: Nylon 11 or 12
- Temperature range: -35°C to 70°C

Explore our range of Couplings and Adaptors



See pages 6-21

Couplings & Adaptors

Hose

Hose Fittings

Tyre Inflation Equipment

Tyre Care

Nitrogen Equipment

Workshop Equipment

Air Tools

Air Tool Accessories



Couplings & Adaptors

Hose

Hose Fittings

Tyre Inflation Equipment

Tyre Care

Nitrogen Equipment

Workshop Equipment

Air Tools

Air Tool Accessories

AIR HOSE

AIR HOSES WITH SWIVEL END FITTINGS

PCL's air hose is available with swivel end fittings. Made from a high-performance TPE compound, it looks and feels like rubber but without its associated downsides.

Available in popular cut lengths complete with end fittings, saving you time and the need for expensive crimping equipment.

Features

- Resistance to oil and fuels
- Good flexibility and kink resistant
- Silicone free
- Excellent abrasion resistance



Part Number	Fittings	Hose Length (m)	Inside Diameter
-------------	----------	-----------------	-----------------

1/4" Hose

HA2011	Rp 1/4 Swivel Ends	5	7 mm / 1/4 in
HA2016	Rp 1/4 Swivel Ends	10	7 mm / 1/4 in
HA2020	Rp 1/4 Swivel Ends	15	7 mm / 1/4 in
HA2001	Rp 1/4 Swivel Ends	20	7 mm / 1/4 in

5/16" Hose

HA2012	Rp 1/4 Swivel Ends	5	8 mm / 5/16 in
HA2017	Rp 1/4 Swivel Ends	10	8 mm / 5/16 in
HA2021	Rp 1/4 Swivel Ends	15	8 mm / 5/16 in
HA2002	Rp 1/4 Swivel Ends	20	8 mm / 5/16 in

3/8" Hose

HA2043	Rp 1/4 Swivel Ends	5	10 mm / 3/8 in
HA2044	Rp 1/4 Swivel Ends	10	10 mm / 3/8 in
HA2045	Rp 1/4 Swivel Ends	15	10 mm / 3/8 in
HA2046	Rp 1/4 Swivel Ends	20	10 mm / 3/8 in
HA2013	Rp 3/8 swivel ends	5	10 mm / 3/8 in
HA2018	Rp 3/8 swivel ends	10	10 mm / 3/8 in
HA2022	Rp 3/8 swivel ends	15	10 mm / 3/8 in
HA2003	Rp 3/8 swivel ends	20	10 mm / 3/8 in

1/2" Hose

HA2019	Rp 1/2 Swivel Ends	10	13 mm / 1/2 in
HA2023	Rp 1/2 Swivel Ends	15	13 mm / 1/2 in
HA2004	Rp 1/2 Swivel Ends	20	13 mm / 1/2 in

- Working pressure: 21 bar / 300 psi
- Burst pressure: 63 bar / 900 psi (3:1 safety factor)
- Temperature range: -15°C to 60°C

Please note - an increase in temperature above 20°C will affect the working pressure quoted above

HIGH VISIBILITY AIR HOSE ASSEMBLIES

This bright yellow hose is manufactured from reinforced material, providing high visibility for extra safety.

Available in popular cut lengths complete with end fittings, saving you time and the need for expensive crimping equipment.

Features

- High visibility to increase safety
- Good flexibility and kink resistant
- Resistance to oil and fuels
- Silicone free



HIGH VISIBILITY HOSE with Rp 1/4 Swivel Ends

Part Number	Hose Length (m)	Inside Diameter
-------------	-----------------	-----------------

HA2044HV	10	10 mm / 3/8 in
HA2022HV	15	10 mm / 3/8 in
HA2046HV	20	10 mm / 3/8 in



HIGH VISIBILITY HOSE with Vertex Coupling and Standard Adaptor

Part Number	Hose Length (m)	Inside Diameter
-------------	-----------------	-----------------

HA2134HV	10	10 mm / 3/8 in
HA2129HV	20	10 mm / 3/8 in

- Working pressure: 20 bar / 290 psi
- Burst pressure: 60 bar / 870 psi (3:1 safety factor)
- Temperature range: -15°C to 60°C

Please note - an increase in temperature above 20°C will affect the working pressure quoted above



AIR HOSE

AIR TOOL HOSE ASSEMBLIES

PCL's air tool hose is made from a high-performance TPE compound which looks and feels like rubber but doesn't have its associated downsides.

Available in popular cut lengths complete with PCL fittings, investing in a PCL air tool hose saves the time and expense of buying expensive crimping equipment.

Just plug in and go.

Features

- Resistance to oil and fuels
- Good flexibility and kink resistant
- Silicone free

- Working pressure: 21 bar / 300 psi
- Burst pressure: 63 bar / 900 psi (3:1 safety factor)
- Temperature range: -15°C to 60°C

Please note - an increase in temperature above 20°C will affect the working pressure quoted above



VERTEX COUPLING & STANDARD ADAPTOR AIR TOOL HOSE

Part Number	Hose Length (m)	Inside Diameter
HA2135	5	8 mm / 5/16 in
HA2125	10	8 mm / 5/16 in
HA2137	15	8 mm / 5/16 in
HA2138	20	8 mm / 5/16 in
HA2133	5	10 mm / 3/8 in
HA2134	10	10 mm / 3/8 in
HA2139	15	10 mm / 3/8 in
HA2129	20	10 mm / 3/8 in



XF-EURO COUPLING & ADAPTOR AIR TOOL HOSE

Part Number	Hose Length (m)	Inside Diameter
HA2140	5	10 mm / 3/8 in
HA2141	10	10 mm / 3/8 in
HA2142	15	10 mm / 3/8 in
HA2143	20	10 mm / 3/8 in

For all air tool applications we recommend 10m hose

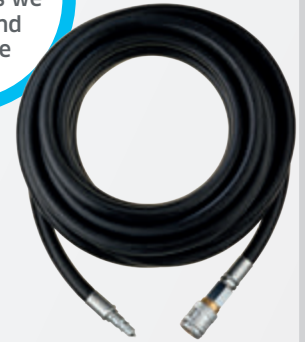

100 SERIES COUPLING & ADAPTOR AIR TOOL HOSE

Part Number	Hose Length (m)	Inside Diameter
HA2144	10	13 mm / 1/2 in
HA2150	15	13 mm / 1/2 in
HA2128	20	13 mm / 1/2 in
HA2152	30	13 mm / 1/2 in

100 SERIES ADAPTOR & R1/2 MALE AIR TOOL HOSE

Part Number	Hose Length (m)	Inside Diameter
HA2110	10	13 mm / 1/2 in
HA2111	20	13 mm / 1/2 in



STANDARD ADAPTOR & R1/4 MALE AIR TOOL HOSE

Part Number	Hose Length (m)	Inside Diameter
HA2112	10	8 mm / 5/16 in
HA2113	20	8 mm / 5/16 in
RHA2036	10	10 mm / 3/8 in
RHA2037	20	10 mm / 3/8 in



Couplings & Adaptors

Hose

Hose Fittings

Tyre Inflation Equipment

Tyre Care

Nitrogen Equipment

Workshop Equipment

Air Tools

Air Tool Accessories



AIR HOSE

AIR TOOL WHIP HOSES

PCL's whip hoses are highly recommended by the Health & Safety Executive's Guide HS(G) 39 as they are designed to distance an air tool from its air supply to prevent vibration. This enables tools to be used safely and helps to prolong the life of couplings and adaptors.



Features

- Helps to prolong the life of couplings and adaptors
- Improves ease of handling - reduces operator fatigue
- Simply "Plug-in and go"

HSE
Essential



Part Number	Fittings	Hose Length	Inside Diameter
HA2108	Standard Adaptor & R 1/4 Male	0.6 m / 2 ft	7 mm / 1/4 in
HA2124N	Standard Adaptor & NPT 1/4 Male	0.6 m / 2 ft	7 mm / 1/4 in
HA2149	Standard Adaptor & R 1/4 Male	0.6 m / 2 ft	10 mm / 3/8 in
HA2109	Standard Adaptor & R 3/8 Male	0.6 m / 2 ft	10 mm / 3/8 in
HA2155	Standard Adaptor & R 3/8 Male	0.4 m / 16 in	8 mm / 5/16 in
HA2116	100 Series Adaptor & R 1/2 Male	0.6 m / 2 ft	13 mm / 1/2 in
HA2132	XF-Euro Adaptor & R 1/4 Male	0.6 m / 2 ft	10 mm / 3/8 in

- Working pressure @ 20°C: 21 bar / 300 psi
- Burst pressure: 63 bar / 900 psi (3:1 safety factor)
- Temperature range: -15°C to 60°C

Please note - an increase in temperature above 20°C will affect the working pressure quoted above

THE IMPORTANCE OF USING AN AIR TOOL WHIP HOSE

Coupling connections are subject to Health and Safety regulations due to the vibrations associated with air tool use. Vibrations can cause the quick disconnect couplings to come loose from the tool, leaving the hose to swing erratically due to air pressure released, which can result in severe injury.

To prevent this, safety guidelines recommend fitting an Air Tool Whip Hose between the air tool and the coupling, distancing the air tool from its air supply and stopping the vibration. The hose end of the assembly is screwed directly to the inlet of the tool, whilst the quick disconnect coupling is screwed into the lubricator or filter/lubricator, six feet from the tool. This distance gives the operator safety room if the coupling were to disconnect under pressure.

For exact guidelines, please see Health & Safety Executive Guide HS(G) 39, which states that "If a quick-acting coupling socket is fitted at the hose end adjacent to the tool, the plug should not be screwed directly into the inlet port but should be fitted onto a short isolation hose". The International Standard (ISO 6150:1998) recommends a minimum of 300mm of flexible hose, thus isolating the plug and socket from the tool vibrations. Also see ISO 4414:1998 and EN 983:1996 for safety requirements covering the installation and use of pneumatic equipment



COILED AIR HOSE ASSEMBLIES

POLYURETHANE COILED AIR HOSE ASSEMBLIES

PU Coiled Air Hose Assemblies are made from Polyurethane (PU) material rather than nylon, increasing the effective working temperature range and removing limitations such as kinking, abrasion and resistance to oils.

PU allows use in any direction, eliminating hose kinks to aid air flow. It also provides ease of use when attached to tools, helps protect tool ends and leaves the work area clear of entanglements and trip hazards. Available in a range of colours, hose sizes and working lengths.



Couplings & Adaptors

Hose

Hose Fittings

Tyre Inflation Equipment

Tyre Care

Nitrogen Equipment

Workshop Equipment

Air Tools

Air Tool Accessories

Part Number	Fittings	Hose Length (m)	Inside Diameter (mm)	Outside Diameter (mm)
Colour: Red				
HA5209	R 1/4 Swivel Ends	2.5	6.5	10
HA5211	R 1/4 Swivel Ends	5	6.5	10
HA5213	R 1/4 Swivel Ends	7.5	6.5	10
HA5216	R 1/4 Swivel Ends	7.5	8	12
HA5218	R 1/4 Swivel Ends	10	8	12
HA5220	R 3/8 Swivel Ends	10	10	15
Colour: Blue				
HA5210	R 1/4 Swivel Ends	2.5	6.5	10
HA5212	R 1/4 Swivel Ends	5	6.5	10
HA5214	R 1/4 Swivel Ends	7.5	6.5	10
HA5217	R 1/4 Swivel Ends	7.5	8	12
HA5219	R 1/4 Swivel Ends	10	8	12
HA5221	R 3/8 Swivel Ends	10	10	15

- Working pressure: 14 bar / 200 psi
- HA5220 & HA5221: Working Pressure: 10 bar / 150 psi



Features

- Polyurethane (PU) material
- Nickel plated 360° swivel fittings
- 200 mm straight ends with spring guard



NYLON COILED AIR HOSE ASSEMBLIES

PCL's Nylon Coiled Air Hose Assemblies are manufactured from top quality nylon resin with nickel-plated 360° swivel fittings. This compact lightweight hose is ideal for workshops where normal tubing may be a trip hazard.

Features

- 200 mm straight ends with spring guard
- Nickel plated 360° swivel ends
- Nylon material

Part Number	Fittings	Hose Length	Inside Diameter (mm)	Outside Diameter (mm)	Colour
HA5201	R 1/4 Swivel Ends	7.6 m / 25 ft	6	8	Red

- Working pressure: 14 bar / 200 psi



HOSE FITTINGS

PCL's hose fittings are designed to complement our vast range of tyre inflation and compressed air products so you can connect your equipment to an existing air line or hose. With the most comprehensive portfolio available on the market, we cover all eventualities, from general maintenance to repairs and emergencies. We also supply an extensive selection of BSP fittings, including male and female adaptors.



Jubilee® Hose Clips

Page 32



PCL Worm Drive Hose Clips

Page 33



Jubilee® 'O' Clips

Page 33



Jubilee® Side Closing 'O' Clip Pincer

Page 33



Jubilee® Flexidriver

Page 33



Jubilee® Clipdriver

Page 33



Jubilee® Workshop Pack

Page 34



Jubilee® 'O' Clip Kits

Page 34



Hose Tail Adaptor

Page 34



Coned Tailpiece

Page 35

BEST SELLER

JUBILEE® HOSE CLIPS

Page 32



Union Swivel Nut

Page 35



Increasing Bush

Page 35



Reducing Bush

Page 35



Double Union

Page 35



Reducing Union

Page 35



Hose Connector/Repairer

Page 36



Flexible Elbow

Page 36



NPT Thread Converter

Page 36



Parallel Socket

Page 36



Y Piece Connector

Page 36



Hose Connector Kit

Page 36



Equal Female Tee

Page 36



Fixed Female Elbow

Page 36



Male Stud

Page 37



Equal Tube Elbow

Page 37



Swivel Elbow

Page 37



Equal Tube Tee

Page 37



Tube to Tube Connector

Page 37



Tube Stem Reducer

Page 37

Hose Fittings



HOSE CLIPS

JUBILEE® HOSE CLIPS

BEST SELLER

The original stainless steel Jubilee® Hose Clip is suitable for most applications. It features a continuously threaded band to enable extra flexibility, maximum band tension and clamping force when adjusting the clip to the correct size. The smooth inside profile of the band and rolled edges give protection for all types of hoses, including soft rubber or silicone hoses.

Jubilee® clips are independently tested by the British Standards Institute (BSI) and carry the British Standard Kitemark™ - a sign of the highest quality and trust recognised across many industries. Also Lloyds Register approved for marine use.



Part Number	Size	BS Number	Adjustment	Box Quantity
Type: Mild Steel Zinc Plated				
JC9512	000	12	9.5 - 12 mm	10
JC1116	M00	16	11 - 16 mm	10
JC1320	00	20	13 - 20 mm	10
JC1622	0	22	16 - 22 mm	10
JC1825	0X	25	18 - 25 mm	10
JC2230	1A	30	22 - 30 mm	10
JC2535	1	35	25 - 35 mm	10
JC3040	1X	40	30 - 40 mm	10
JC3245	1M	45	32 - 45 mm	10
JC3550	2A	50	35 - 50 mm	10
JC4055	2	55	40 - 55 mm	10
JC4560	2X	60	45 - 60 mm	10
JC5570	3	70	55 - 70 mm	10
JC6080	3X	80	60 - 80 mm	1
JC7090	4	90	70 - 90 mm	1
JC85100	4X	100	85 - 100 mm	1
JC90120	5	120	90 - 120 mm	1
JC110140	6	140	110 - 140 mm	1
JC120150	6X	150	120 - 150 mm	1
JC135165	7	165	135 - 165 mm	1
JC158190	7.5	190	158 - 190 mm	1
JC184216	8.5	216	184 - 216 mm	1
JC210242	9.5	242	210 - 242 mm	1
JC235267	10.5	267	235 - 267 mm	1
JC260292	11.5	292	260 - 292 mm	1
JC286318	12.5	318	286 - 318 mm	1

Part Number	Size	BS Number	Adjustment	Box Quantity
Type: 304 Stainless Steel				
JC9512/ST	000	12	9.5 - 12 mm	10
JC1116/ST	M00	16	11 - 16 mm	10
JC1320/ST	00	20	13 - 20 mm	10
JC1622/ST	0	22	16 - 22 mm	10
JC1825/ST	0X	25	18 - 25 mm	10
JC2230/ST	1A	30	22 - 30 mm	10
JC2535/ST	1	35	25 - 35 mm	10
JC3040/ST	1X	40	30 - 40 mm	10
JC3245/ST	1M	45	32 - 45 mm	10
JC3550/ST	2A	50	35 - 50 mm	10
JC4055/ST	2	55	40 - 55 mm	10
JC4560/ST	2X	60	45 - 60 mm	10
JC5570/ST	3	70	55 - 70 mm	10
JC6080/ST	3X	80	60 - 80 mm	1
JC7090/ST	4	90	70 - 90 mm	1
JC85100/ST	4X	100	85 - 100 mm	1
JC90120/ST	5	120	90 - 120 mm	1
JC110140/ST	6	140	110 - 140 mm	1
JC120150/ST	6X	150	120 - 150 mm	1
JC135165/ST	7	165	135 - 165 mm	1
JC158190/ST	7.5	190	158 - 190 mm	1
JC184216/ST	8.5	216	184 - 216 mm	1
JC210242/ST	9.5	242	210 - 242 mm	1
JC235267/ST	10.5	267	235 - 267 mm	1
JC260292/ST	11.5	292	260 - 292 mm	1
JC286318/ST	12.5	318	286 - 318 mm	1



HOSE CLIPS

PCL WORM DRIVE HOSE CLIPS

PCL's Worm Drive Hose Clips are available in Mild Steel Zinc Plated or 304 Stainless Steel in a range of popular sizes from 9.5 to 40 mm. Their continuously threaded band provides maximum band tension and clamping force when adjusting the clip to the correct size.



Part Number	Clamping Range	Box Quantity
Type: Mild Steel Zinc Plated		
PC9512	9.5 - 12 mm	10
PC1116	11 - 16 mm	10
PC1320	13 - 20 mm	10
PC1622	16 - 22 mm	10
PC1825	18 - 25 mm	10
PC2230	22 - 30 mm	10

Part Number	Clamping Range	Box Quantity
Type: Mild Steel Zinc Plated		
PC2535	25 - 35 mm	10
PC3040	30 - 40 mm	10
Type: 304 Stainless Steel		
PC1116SS	11 - 16 mm	10
PC1320SS	13 - 20 mm	10
PC1825SS	18 - 25 mm	10

JUBILEE® 'O' CLIPS

Jubilee® 'O' Clips are two ear clamps, mainly used on air, fluid, gas and steam lines but also suitable for low pressure hydraulic applications. Instead of a screw mechanism, pincers are used to provide a secure seal, crimping the ears of the clamp. This makes them particularly useful on extremely small hoses. The tamper-proof nature of the fitting makes Jubilee® 'O' Clips ideal for when a neat finish is required, with no bulky housing to catch on obstructions.



Part Number	Size	Clamping Range	Box Quantity
OC0305	0305	3 - 5 mm	50
OC0507	0507	5 - 7 mm	50
OC0709	0709	7 - 9 mm	50
OC0911	0911	9 - 11 mm	50
OC1113	1113	11 - 13 mm	50
OC1315	1315	13 - 15 mm	50
OC1417	1417	14 - 17 mm	50
OC1518	1518	15 - 18 mm	50
OC1720	1720	17 - 20 mm	50
OC1821	1821	18 - 21 mm	50

Part Number	Size	Clamping Range	Box Quantity
OC2023	2023	20 - 23 mm	50
OC2225	2225	22 - 25 mm	25
OC2327	2327	23 - 27 mm	25
OC2528	2528	25 - 28 mm	25
OC2831	2831	28 - 31 mm	25
OC3134	3134	31 - 34 mm	25
OC3437	3437	34 - 37 mm	25
OC3740	3740	37 - 40 mm	25
OC4043	4043	40 - 43 mm	25
OC4346	4346	43 - 46 mm	25

HOSE CLIP TOOLS

JUBILEE® SIDE CLOSING 'O' CLIP PINCER

The high-precision Side Closing Pincer is especially designed to easily crimp and obtain a secure seal of Jubilee® 'O' Clips (two ear clamps).



Part Number	Description
CPR01	Jubilee® Side Closing 'O' Clip Pincer

JUBILEE® FLEXIDRIVER

The Flexidriver is invaluable for the efficient, rapid and easy adjustment of Jubilee® hose clips, featuring a flexible shaft designed to reach all those awkward places.



Part Number	Description
FDR1	Jubilee® Flexidriver

JUBILEE® CLIPDRIVER

With its rigid shaft and 7mm socket driver, the Jubilee® Clipdriver is designed for the easy adjustment of Jubilee® hose clips in inaccessible areas.

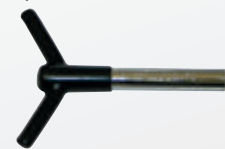

Part Number	Description
CDR95	95 mm Jubilee® Clipdriver



Couplings & Adaptors

Hose

Hose Fittings

Tyre Inflation Equipment

Tyre Care

Nitrogen Equipment

Workshop Equipment

Air Tools

Air Tool Accessories

HOSE CLIP PACKS



JUBILEE® WORKSHOP PACK

The Jubilee® Workshop Pack contains 143 of the most popular Mild Steel Zinc Plated Jubilee® Hose Clips, ranging from 9.5 mm to 40 mm. Supplied in a sturdy plastic, reusable box, suitable for any tough industrial environment.

Part Number	Dimensions (mm)	Kit Contents
WP143	55H x 330W x 250D	x32: MOOMS x28: OOMS x24: OOOMS x13: OMS, 1MS x7: 1XMS x14: OXMS x12: 1AMS

JUBILEE® 'O' CLIP KITS

The 'O' Clip Kit from Jubilee® is handy for when you need a selection of different size clips on the move. This versatile, convenient dispenser is suitable for the most popular sizes of double ear clips, with or without a side closing pincer.



OK175



OK175P

Part Number	Dimensions (mm)	Kit Contents
OK175	40h X 270w X 175d	x20: 0507, 0911, 1113, 1417, 1518, 1720 x25: 0709 x30: 1315
OK175P	40h X 270w X 175d	As above plus x1: Jubilee® Side Closing 'O' Clip Pincer

HOSE CONNECTORS

HOSE TAIL ADAPTOR

This corrosive-resistant, plated Hose Tail Adaptor connects the hose to a female fitting.



Part Number	Hose Internal Diameter
Male Thread: R 1/4	
HC1205	4.75 mm / 3/16 in
HC5656	6.35 mm / 1/4 in
HC1206	7.9 mm / 5/16 in
HC1217	9.5 mm / 3/8 in
HC2479	12.7 mm / 1/2 in

Part Number	Hose Internal Diameter
Male Thread: R 3/8	
HC6904	6.35 mm / 1/4 in
HC6905	7.9 mm / 5/16 in
HC2951	9.5 mm / 3/8 in
HC2808	12.7 mm / 1/2 in
Male Thread: R 1/2	
HC6908	9.5 mm / 3/8 in
HC2954	12.7 mm / 1/2 in
Male Thread: 1/4 NPT	
HC9336	6.35 mm / 1/4 in



HOSE CONNECTORS

CONED TAILPIECE

Made from hardened steel with corrosive-resistant plating for long life and durability, the Coned Tailpiece is used in conjunction with union nuts to connect the hose to a male threaded fitting.



Part Number Hose Internal Diameter

Union Nut Size: R 1/4	
HC5030	4.75 mm / 3/16 in
HC5275	6.35 mm / 1/4 in
HC5276	7.9 mm / 5/16 in
HC1225	9.5 mm / 3/8 in
Union Nut Size: R 3/8	
HC2595	6.35 mm / 1/4 in
HC2594	7.9 mm / 5/16 in
HC2192	9.5 mm / 3/8 in

CONED TAILPIECE & UNION NUT

The corrosive-resistant Coned Tailpiece and Union Nut come together in various combinations for different connection types.



Part Number Hose Internal Diameter

Female Thread: Rp 1/4	
HC5194 + HC5030	4.75 mm / 3/16 in
HC5275/5194	6.35 mm / 1/4 in
HC5276/5194	7.9 mm / 5/16 in
HC1226 + HC1225	9.5 mm / 3/8 in
Female Thread: Rp 3/8	
HC2595 + HC2181	6.35 mm / 1/4 in
HC2181 + HC2594	7.9 mm / 5/16 in
HC2192/2181	9.5 mm / 3/8 in

DOUBLE UNION

This corrosive-resistant nut is used to connect fittings (male to male).

Part Number Male Thread

HC6560	R 1/4
HC4281	R 3/8
HC6898	R 1/2



UNION SWIVEL NUT

The corrosive-resistant Union Swivel Nut is used in conjunction with Coned Tailpieces for various connection types.



Part Number Suitable For Coned Tailpiece Part Number

Female Thread: Rp 1/4		
HC5194	4.75 mm / 3/16 in to 7.9 mm / 5/16 in	HC5030, HC5275, HC5276
HC1226	9.5 mm / 3/8 in	HC1225
Female Thread: Rp 3/8		
HC2181	6.35 mm / 1/4 in to 9.5 mm / 3/8 in,	HC2192, HC2594

INCREASING BUSH

The corrosive-resistant Increasing Bush is used to increase thread size when connecting differing hose diameters (male to female).



Part Number Male Thread Female Thread

HC6475	R 1/4	Rp 3/8
--------	-------	--------

REDUCING BUSH

The corrosive-resistant Reducing Bush is used to increase thread size when connecting differing hose diameters.



Part Number Thread Type Thread Type

HC6895	R 3/8 (Male)	Rp 1/4 (Female)
HC6896	R 1/2 (Male)	Rp 1/4 (Female)
HC6897	R 1/2 (Male)	Rp 3/8 (Female)
HC6892	Rp 3/8 (Female)	Rp 1/4 (Female)
HC6893	Rp 1/2 (Female)	Rp 1/4 (Female)

REDUCING UNION

The corrosive-resistant Reducing Union is used to connect fittings.

Part Number Male Thread (1) Male Thread (2)

HC6899	R 3/8	R 1/4
HC6900	R 1/2	R 1/4
HC6901	R 1/2	R 3/8



Couplings & Adaptors

Hose

Hose Fittings

Tyre Inflation Equipment

Tyre Care

Nitrogen Equipment

Workshop Equipment

Air Tools

Air Tool Accessories



HOSE CONNECTORS

Couplings & Adaptors

Hose

Hose Fittings

Tyre Inflation Equipment

Tyre Care

Nitrogen Equipment

Workshop Equipment

Air Tools

Air Tool Accessories

HOSE CONNECTOR/REPAIRER

Perfect for repairing damage along a line of hose, or for connecting two lengths of hose together.

Part Number	Hose Internal Diameter
HC2983	6.35mm / 1/4 in
HC2984	7.9mm / 5/16 in
HC2985	9.5mm / 3/8 in
HC2986	12.7mm / 1/2 in



NPT THREAD CONVERTER

Specially designed to allow PCL couplings and adaptors to be fitted to 1/4 NPT threads.

Part Number	Male Thread	Female Thread
HC9560	1/4 NPT	Rp 1/4
HC9573	R 1/4	1/4 NPT



Y PIECE CONNECTOR

For splitting a single connection into two, the Y Piece enables the use of more than one air tool.

Part Number	Female Thread
SPR4279	Rp 1/4
SPR4280	Rp 3/8
HC2043-1/2	Rp 1/2



HOSE CONNECTOR KIT

Ideal for service engineers, or for workshops in case of a hose failure, this handy kit includes genuine PCL Hose Tails, Union Nuts, Coned Tailpieces and Reducing Bushes - all stored in a solid compact pocket case.



Part Number	Kit Contents
HCKIT01	x4: HC5194 x3: HC5656, HC1206, HC1217 x2: HC2479, HC5276, HC5275, HC1226, HC6897, HC1225 x1: HC6560, HC6895, HC6896

FLEXIBLE ELBOW

A flexible connection used to eliminate hose kinks.

Part Number	Working Pressure	Male Thread	Female Thread
FE101	140 psi / 10 bar	R 1/4	Rp 1/4



PARALLEL SOCKET

A corrosive-resistant plated socket used for straight connections.

Part Number	Female Thread (1)	Female Thread (2)
HC6889	Rp 1/4	Rp 1/4
HC2543-3/8	Rp 3/8	Rp 3/8
HC2543-1/2	Rp 1/2	Rp 1/2



EQUAL FEMALE TEE

An intermediate equal female tee connector which can be connected and disconnected with one hand, without tools. Suitable for equal tee female connections.

Part Number	Female Thread
HC2003-1/4	Rp 1/4
HC2003-3/8	Rp 3/8
HC2003-1/2	Rp 1/2



FIXED FEMALE ELBOW

For 90° female to female connections, designed to assist with the assembly of fluid power components and systems.

Part Number	Female Thread
HC2013-1/4	G 1/4
HC2013-3/8	G 3/8
HC2013-1/2	G 1/2





PUSH-IN FITTINGS

MALE STUD

Made from corrosive-resistant brass, this straight, conical male connector can be connected and disconnected with one hand.



Part Number Connection (in)

External Diameter (mm): 4	
PMS04M5	M5
PMS401	1/8
PMS402	1/4
External Diameter (mm): 6	
PMS601	1/8
PMS602	1/4
External Diameter (mm): 8	
PMS801	1/8
PMS802	1/4
PMS803	3/8
External Diameter (mm): 10	
PMS1002	1/4
PMS1003	3/8
PMS1004	1/2
External Diameter (mm): 12	
PMS1202	1/4
PMS1203	3/8
PMS1204	1/2



TUBE TO TUBE CONNECTOR

A straight, intermediate tube to tube connector; connection and disconnection can be performed with one hand.

Part Number External Diameter (mm)

PTC4	4
PTC6	6
PTC8	8
PTC10	10
PTC12	12

EQUAL TUBE ELBOW

An intermediate elbow connector, available in a range of external diameters.



Part Number External Diameter (mm)

PEE4	4
PEE6	6
PEE8	8
PEE10	10
PEE12	12

SWIVEL ELBOW

A connector for push-in fittings, available in a range of external diameters.



Part Number Connection (in)

External Diameter (mm): 4	
PSE401	1/8
PSE402	1/4
External Diameter (mm): 6	
PSE601	1/8
PSE602	1/4
External Diameter (mm): 8	
PSE801	1/8
PSE802	1/4
PSE803	3/8
External Diameter (mm): 10	
PSE1002	1/4
PSE1003	3/8
PSE1004	1/2
External Diameter (mm): 12	
PSE1202	1/4
PSE1203	3/8
PSE1204	1/2

Constructed from nickel-plated brass 58 to protect against corrosion



EQUAL TUBE TEE

An intermediate 'T' connector, available in a range of external diameters.

Features

Part Number External Diameter (mm)

PET4	4
PET6	6
PET8	8
PET10	10
PET12	12



TUBE STEM REDUCER

An intermediate tube to stem reducer, available in a variety of diameters.

Part Number Stem Diameter (mm)

External Diameter (mm): 4	
PSR46	6
PSR48	8
External Diameter (mm): 6	
PSR68	8
PSR610	10
PSR612	12
External Diameter (mm): 8	
PSR810	10
PSR812	12
External Diameter (mm): 10	
PSR1012	12

TYRE INFLATION EQUIPMENT



PCL offers the highest quality, most reliable and cost-effective equipment for fast and accurate tyre inflation. From handheld analogue units, to the high-tech ACCURA electronic range - PCL's innovative, market-leading inflators provide the best and most select range of functionality for all types of tyre inflation applications throughout the world.



ACCURA D10 Tyre Inflator

Page 41



Mechanical Units

Page 41



ACCURA QUBE Series II Tyre Inflator

Page 42



ACCURA D12 & D13 Tyre shop Inflator

Page 42



AIRFORCE MK4 Tyre Inflator

Page 44



AIRFORCE MK4 Truck Tyre Inflator

Page 44



AIRFORCE MK4 High Pressure Tyre Inflator

Page 45



AIRFORCE MK4 Aviation Tyre Inflator

Page 45



AIRlite eco Tyre Inflator

Page 45



ACCURA MK4 Digital Tyre Inflator

Page 46

BEST SELLER

ACCURA QUBE SERIES II TYRE INFLATOR



See range on 42

BEST SELLER

AIRFORCE® MK4 TYRE INFLATOR



See range on 44

BEST SELLER

ACCURA® MK4 DIGITAL TYRE INFLATOR



See range on 46



ACCURA 1 Tyre Inflator

Page 47



DTI Tyre Inflator

Page 48



ACCURA 5 High Pressure Tyre Inflators

Page 48



ACCURA 5 Aviation Tyre Inflator

Page 47



AirForce II Tyre Inflator

Page 49



ATI Tyre Inflator

Page 49



Economy Alloy Tyre Inflator

Page 50



Economy Blowgun Style Tyre Inflator

Page 50



Footpumps

Page 50



Twin Hold-on Connectors

Page 51



Twin Clip-on Connectors

Page 51



Single Clip-on Connectors - Open end

Page 52



Single Clip-on Connectors - Closed end

Page 52



Swivel Clip-on Connectors

Page 52



Euro Style Connectors

Page 52



TPMS Friendly FLEXI Tyre Valve Connector

Page 53



Large Bore Connectors

Page 53



Other Specialist Connectors

Page 53



Thumb-lock Connector

Page 53



Valve Core Retracting Tool

Page 53

Tyre Inflation Equipment



WHY IS TYRE INFLATION IMPORTANT?



- First and foremost, air carries the majority of the load
- The 'contact patch' of an inflated tyre is critical to maximise vehicle stability & ultimately **road safety**
- It is well documented by vehicle and tyre manufacturers that tyre inflation affects **braking performance, tyre wear and fuel efficiencies**
- Yet a shocking 35% of tyres are being driven **at least 8psi/0.5bar** below the vehicle manufacturer's recommendation

How does using high quality tyre inflation equipment affect safety and performance?

Equipment User	Vehicle Operator
Operational Safety	Increased Safety
Error risks minimised	Improved Fuel consumption
Cost effective and trouble-free life	Decreased tyre wear
Minimised operating costs	Improved waiting/service times
High levels of flexibility	Reduce tyre related incidents and delays

SHOULD I CHOOSE A FIXED OR MANUAL INFLATOR?

There are two core types of inflator:

- **Fixed** - where the operator pre-sets the pressure then the inflator recognises when the set level is reached.
- **Manual** - where the operator determines both the required pressure and when the final pressure is reached.

Fixed Inflators

Fixed models are electronic in design, offering high levels of repeatable accuracy and a reduced risk of user error, and can be used in conjunction with cages. The pre-set function enables the operator to carry out other tasks during the inflation process, thereby increasing efficiency, uptime, and safety, whilst reducing the effort and fatigue associated with inflating large, high-pressure tyres from flat.

Manual Inflators

Non-pre-set/manual are handheld and include three key types of unit: Linear, dial and digital.

Handheld inflators are a cost-effective option where flexibility is required, for example when working in various locations in a workshop or outside, as they do not require mains power.

It may be that a combination of pre-set and non-pre-set inflators is the best choice to cost-effectively meet the varying demands of a workshop.

FIXED TYRE INFLATOR

WHAT TYPE OF FIXED INFLATOR DO I NEED?

Which features of a pre-set unit will work best for you?

PCL's comprehensive ACCURA portfolio includes the widest choice of fixed products available on the market, offering a solution for an extensive range of markets - from aviation, truck and car tyres to vessels such as footballs.

Should I opt for "better" or "best"?

- PCL's "better" range of fixed inflators is made from high performance engineering plastics, ideal for automotive applications.
- The more robust "best" units feature a die-cast aluminium design, bigger screen and enhanced electronics offering bespoke options, including a multi-hose model.

If space and cost savings are key then the "better", user-friendly ACCURA QUBE electronic pre-set unit offers superb value and fast, accurate tyre inflation, now with an additional 4-button pre-set option.



Couplings & Adaptors

Hose

Hose Fittings

Tyre Inflation Equipment

Tyre Care

Nitrogen Equipment

Workshop Equipment

Air Tools

Air Tool Accessories



FIXED TYRE INFLATOR

ACCURA D10 TYRE INFLATOR

This is the premium pre-set tyre inflator for forecourts, workshops and garages where fast, safe, secure and time-saving inflation is key. Combining the latest electronic inflation technology with user-friendly controls, the D10 allows the operator to pre-set the required pressure and get on with other tasks whilst the inflator does the rest, thereby increasing workshop efficiency. The D10 also reduces operational expenses and long-term equipment costs, whilst actively boosting safety - which is of vital importance to modern regulations.



ALSO AVAILABLE » AIRCRAFT HIGH PRESSURE VERSION



Features

- Auto-start inflation
- Audible and visual end of cycle signal
- Default to safe setting
- Bespoke variants available inc. dual screen
- Aluminium die-cast housing and strong quality image and branding
- Complies with EC Directive BS EN12645:2014

Part Number Description

D10	Wall mounted
D20	Pedestal mounted
D25	Pedestal mounted air & water

- Accuracy: 0.01 bar / 0.1 psi / 2 kPa / 0.01 kgf/cm² (exceeds EC Directive BS EN12645:2014)
- Maximum inflation pressure: 10 bar / 145 psi / 999 kPa / 10 kgf/cm²
- Resolution: 0.1 bar / 1 psi / 5 kPa / 0.1 kgf/cm²



MECHANICAL UNITS

An innovative range of mechanical tyre inflators reflects PCL's on-going design excellence and the enduring popularity of the mechanical unit. The WM/PM premium dial product, with its large, clear and robust dial for speed, safety and ease of use, makes it the product of choice for long life in tough environments.

Features

- Clear impact-resistant toughened glass dial cover
- Long trouble-free life and performance
- Complies with EC Directive BS EN12645:2014

Part Number Description Hose Type

WM1	Wall mounted	7.6 m Co-axial
WM2	Wall mounted	7.6 m Twin Twisted
WM3	Wall mounted	7.6 m Air Hose
PM1	Pedestal mounted	7.6 m Co-axial

- Accuracy: 0.01 bar / 0.1 psi / 2 kPa / 0.01 kgf/cm² (exceeds EC Directive BS EN12645:2014)
- Maximum inflation pressure: 10 bar / 145 psi / 999 kPa / 10 kgf/cm²
- Resolution: 0.1 bar / 1 psi / 5 kPa / 0.1 kgf/cm²



Couplings & Adaptors

Hose

Hose Fittings

Tyre Inflation Equipment

Tyre Care

Nitrogen Equipment

Workshop Equipment

Air Tools

Air Tool Accessories



FIXED TYRE INFLATOR

ACCURA QUBE SERIES II TYRE INFLATOR

BEST SELLER

PCL's new plug and play ACCURA QUBE Series II is built for simplicity and versatility to save time and money. Combining the latest electronics and touch button technology in a user-friendly, space-saving design, it provides fast, safe and accurate Air and N2 inflation.

The latest QUBE is even more robust and offers higher levels of speed and accuracy, with new "human-touch" recognition software added to the buttons. An additional 4 preset button module allows common pressures to be set quickly, speeding up straight-forward processes in workshops, garages and factories. All the customer needs to do is pre-set the required pressure, place the connector on the tyre, and let the inbuilt auto-start function do the rest.



Features

- Simple and easy to use with touch screen technology
- Plug and Play; Saves time and money in workshop operations
- New 4 button option increases savings in operations even further
- OPS and Nitrogen (N2) purge modes
- Individually tested and certified to meet EC Accuracy BS EN12645:2014

Part Number	Description	Hose Length	Tyre Valve Connection
QUBE1	230v (UK style plug)	5 m / 16 ft	Euro clip-on
QUBE1/4P	230v (UK style plug) with 4 preset buttons	5 m / 16 ft	Euro clip-on
QUBE3	230v (Australian style plug)	5 m / 16 ft	Euro clip-on
QUBE4	120v (US style plug)	5 m / 16 ft	Euro clip-on
QUBE6	12v (No plug)	N/A	N/A
QUBE9	230v (EU style plug)	5 m / 16 ft	Euro clip-on

ACCURA D12 & D13 TYRE SHOP INFLATOR

PCL's premium ACCURA range includes the D12 and D13 tyre inflators. Featuring advanced, user-friendly design, touch screen and leading sensor technology, they incorporate tyre shop specific software with a default to last setting, over pressure mode and N2 purging.

The D12 provides increased cost savings for professional tyre applications - including commercial and retail tyre shops, mobile tyre fleets, automotive OEMs, garages, car dealers and transport depots - and enhanced safety, which is of vital importance in light of today's strict regulations. The D13 builds on the standard D12, with multi-tyre capabilities further reducing tyre inflation times by allowing the user to inflate up to 4 tyres at once.

Features

- Bead seat over pressure facility (OPS)
- Fast inflation times
- Nitrogen (N2) purge
- Auto-start inflation
- Bespoke capabilities to tailor to specialist requirements
- Complies with BS EN 12645:2014

Part Number	Description
D12	Wall mounted
D13	Wall mounted multi-hose variant

- Accuracy: 0.01 bar / 0.1 psi / 2 kPa / 0.01 kgf/cm² (exceeds EC Directive BS EN 12645:2014)
- Maximum inflation pressure: 10 bar / 145 psi / 999 kPa / 10 kgf/cm²
- Resolution: 0.1 bar / 1 psi / 5 kPa / 0.1 kgf/cm²



Couplings & Adaptors

Hose

Hose Fittings

Tyre Inflation Equipment

Tyre Care

Nitrogen Equipment

Workshop Equipment

Air Tools

Air Tool Accessories

LINEAR HANDHELD INFLATORS

HOW TO CHOOSE THE RIGHT HANDHELD INFLATOR

Choosing the right style of handheld for your needs comes down to personal preference and PCL offers a range of performance options within each of the linear, dial and digital types.

Linear gauges

Highly robust, offering a good range of indoor and outdoor capabilities, linear gauges display a pressure reading on a horizontal scale, with the indicator position determined by the contraction of a carefully calibrated and sensitive spring delivered by the pressure in a tyre or other vessel. The life and accuracy of the gauge is dependent upon the spring's accuracy, as well as the valve mechanism, with PCL's market-leading AIRFORCE® MK4 being the number one in the world. The range now includes the entry level Airlite eco Tyre Inflator.

Dial gauges

Dial gauges provide a calibrated face with a needle which moves to point to the pressure level within the tyre being inflated. The needle movement can be controlled by mechanical methods such as Bourdon tube, bellow or diaphragm. The quality of the dial mechanism controls the quality, accuracy and life. PCL offers three product levels: "premium/best" fully EC-approved and tested for all environments including the most demanding and where accuracy is key; "better" for mid-range workshops; and "good" for where intensity is low and tight accuracy less important.

Digital gauges

Electronic inflators display a digital readout with pressure measured by an electronic pressure sensor which is both accurate and easy to read. PCL provides a solution for all working environments, ranging from the highly accurate ACCURA 1 with ceramic sensor to the flexible and environmentally tolerant ACCURA® MK4.

Extended Warranty now available on PCL's premium MK4 range



Considerable investments have been made into the world-leading MK4 range, reinforcing PCL's confidence in the digital handheld ACCURA® MK4 and linear AIRFORCE® MK4 products to the extent that the warranty has been doubled from one to two years. This extension reflects the MK4's longevity within the most demanding of tyre shop and garage environments, where it provides enhanced durability in intensive indoor and outdoor applications.



Couplings & Adaptors

Hose

Hose Fittings

Tyre Inflation Equipment

Tyre Care

Nitrogen Equipment

Workshop Equipment

Air Tools

Air Tool Accessories



LINEAR HANDHELD INFLATORS

AIRFORCE® MK4 TYRE INFLATOR

BEST SELLER



As the world's leading linear gauge, the AIRFORCE® MK4 takes performance to a new level, offering even greater ease of use with a 20% larger screen and clearer to read scale. Meanwhile PCL's leading high performance two-stage valve design ensures accuracy and longer life compared to competitors' single-stage mechanisms, where filters are used in an attempt to protect the product. This can result in over 50% reduction in product life, with filters slowing down inflation rates, wasting valuable technician time.

Tests show the AIRFORCE® MK4 can cover more than ten times as many cycles as its main contender, making it the product of choice for users who prefer a linear tool.

Features

- New viewing window - Larger window gives 20% greater field of viewing
- Lighter weight - Less work strain and easier for repetitive use
- Biomorphic Shape - Ergonomic, easier to use and less prone to damage when dropped
- New valve mechanism - Simplified 2 stage mechanism design gives longest life available and reduces fatigue in use
- Improved piston & seal design - No internal corrosion, no sticking and no skewing of accuracy
- Accuracy standards - Tested to over 400,000 cycles at 100% accuracy

Part Number	Hose Length	Tyre Valve Connection	Calibration
AFG4H03	0.53 m / 21 in	Twin hold-on	0-138 psi / 0-9.6 bar
AFG4H04	0.53 m / 21 in	Single clip-on	0-138 psi / 0-9.6 bar
AFG4H031	0.36 m / 14 in	Short stem twin hold-on	0-138 psi / 0-9.6 bar
AFG4H05	1.8 m / 6 ft	Twin clip-on	0-138 psi / 0-9.6 bar
AFG4H06	2.7 m / 9 ft	Twin clip-on	0-138 psi / 0-9.6 bar
AFG4H061	2.7 m / 9 ft	Single clip-on	0-138 psi / 0-9.6 bar

Accuracy complies to:
EN12645:2014



AIRFORCE® MK4 TRUCK TYRE INFLATOR

PRESSURE UP TO » 120 PSI (12 BAR) 

PCL has drawn on over 80 years of world-leading tyre inflation knowledge to create the new, heavy duty AIRFORCE® MK4 Truck Tyre Inflator. The AFG5 can inflate up to 174 psi (12 bar) and is robust, reliable and versatile with its aluminium die cast body and linear gauge.

The same key features of the AIRFORCE® MK4 plus:

Features

- Higher inflation pressures up to 174 psi (12 bar) to cope with commercial tyres of all types
- Accuracy Standards - Tested to over 400,000 cycles at 100% accuracy

Part Number	Hose Length	Tyre Valve Connection	Calibration
AFG5H36	3.6 m / 12 ft	Twin clip-on	0-174 psi / 0-12 bar



Accuracy complies to: EN12645:2014



LINEAR HANDHELD INFLATORS

AIRFORCE® MK4 HIGH PRESSURE TYRE INFLATOR

PRESSURE UP TO » 300 PSI (21 BAR)

PCL's High Pressure AIRFORCE® MK4 is designed for harsh, commercial environments, providing flexibility with pressures up to an impressive 300 psi (21 bar). Capable of withstanding extreme weather, it is ideally suited to transport, mining or industrial applications requiring high tyre inflation pressures.

The same key features of the AIRFORCE® MK4 plus:

Features

- Higher inflation pressures from 45 - 300 psi (3 - 21 bar) to cope with commercial tyres, industrial and aviation applications
- Accuracy Standards - Tested to over 400,000 cycles at 100% accuracy

Part Number	Hose Length	Tyre Valve Connection	Calibration
AFG6H04	1.8 m / 6 ft	Single clip-on	45-300 psi / 3-21 bar
AFG6H041	1.8 m / 6 ft	Twin clip-on	45-300 psi / 3-21 bar



Accuracy complies to: EN12645:2014

AIRFORCE® MK4 AVIATION TYRE INFLATOR

PRESSURE UP TO » 300 PSI (21 BAR)



The AIRFORCE® MK4 Aviation Tyre Inflator is capable of inflating up to an impressive 300 psi (21 bar) to suit tyres within the aeronautics industry. The latest version of PCL's aviation tyre inflator, used all over the world, now features all updates from the newly designed MK4, with increased visibility, improved valve mechanism and enhanced gauge design increasing life and accuracy in all environments for aviation.

The same key features of the AIRFORCE® MK4 plus:

Features

- Higher inflation pressures up to 300 psi (21 bar) to cope with aviation tyres of all types
- Robust and environmentally strong designed to cope with high intensity aviation applications

Part Number	Hose Length	Tyre Valve Connection	Calibration
AFG6A01	x2 2 m 4G1 hydraulic oil resistant armored hose	8v1 Screw-on and 12v1 Screw-on	45-300 psi / 3-21 bar



- Resolution: 5 psi
- Maximum inlet pressure: 362 psi

AIRLITE ECO TYRE INFLATOR

Manufactured from nylon filled polymer, PCL's new Airlite eco Tyre Inflator handles the pressures without breaking the bank. It's customer led ergonomic design and the natural insulation of the polymer ensures user comfort. A must have, cost-effective addition to general trade or an auto enthusiast's tool kits.

Features

- Increased window size ensures clearer vision along with accuracy
- Textured thumb lever allows greater control and comfort when inflating or deflating

Part Number	Hose Length	Tyre Valve Connection	Calibration
LAG1H03	0.4 m	Twin hold-on	0-140 psi / 0-9.6 bar
LAG1H08	0.4 m	Euro clip-on	0-140 psi / 0-9.6 bar



ALSO AVAILABLE » For an EC Directive BS EN12645:2014 approved Linear Inflator with calibration certificate, please specify the premium AIRFORCE® MK4

Couplings & Adaptors

Hose

Hose Fittings

Tyre Inflation Equipment

Tyre Care

Nitrogen Equipment

Workshop Equipment

Air Tools

Air Tool Accessories

TYRE INFLATION EQUIPMENT



DIGITAL HANDHELD INFLATORS

ACCURA® MK4 DIGITAL TYRE INFLATOR

BEST SELLER

Couplings & Adaptors

Hose

Hose Fittings

Tyre Inflation Equipment

Tyre Care

Nitrogen Equipment

Workshop Equipment

Air Tools

Air Tool Accessories



The ACCURA® MK4 takes the concepts of the world-leading MK4 into the digital age with a unique combination of the lightness, accuracy and ease of use of a digital inflator and the robustness of the toughest analogue available. The ACCURA® MK4 offers both leading inflation and deflation rates and the highest levels of accuracy and flexibility, with high performance for both indoor and outdoor applications.

The large size LCD, backlit screen and selectable units of pressure reading make this the most versatile digital handheld product PCL has ever manufactured. The ACCURA® MK4 Tyre Inflator is available with a wide choice of tyre valve connectors and hose lengths to suit all tyre inflation applications.

Part Number	Hose Length	Tyre Valve Connection	Calibration
DAC403	0.53 m / 21 in	Twin hold-on	4-250 psi / 0.3-17.2 bar / 30-1723 kPa
DAC404	0.53 m / 21 in	Single clip-on	4-250 psi / 0.3-17.2 bar / 30-1723 kPa
DAC405	1.8 m / 6 ft	Twin clip-on	4-250 psi / 0.3-17.2 bar / 30-1723 kPa
DAC406	2.7 m / 9 ft	Twin clip-on	4-250 psi / 0.3-17.2 bar / 30-1723 kPa
DAC4061	2.7 m / 9 ft	Single clip-on	4-250 psi / 0.3-17.2 bar / 30-1723 kPa
DAC436	3.6 m / 12 ft	Twin clip-on	4-250 psi / 0.3-17.2 bar / 30-1723 kPa

Accuracy complies to: **BS EN12645:2014**

Features

- Slimline biomorphic body shape gives increased comfort for the user
- Higher pressure range for multiple applications 4 - 250 psi range (including trucks)
- Permanently backlit in use, auto off after 25 seconds no-use - Easy to read in dark workshops or at night
- Large screen and clear digits - Easy and quick to read
- Individually tested and certified against national approved gauges
- Long battery life - 400 hours of use - Replaceable 2 X AAA batteries power unit (supplied)
- 3 units of calibration toggle as standard - psi, bar & kPa



DIGITAL HANDHELD INFLATORS



ACCURA 1 TYRE INFLATOR

Widely accepted as the best product available for measuring and checking Tyre Pressure Monitoring Systems (TPMS), PCL's ACCURA 1 broke the mould for handheld units, merging ease of use and readability with rapid, safe and cost-effective tyre inflation.

This robust yet sophisticated unit combines leading electronics and sensor technology with patented software algorithms for trouble-free inflation and deflation. Its biomorphic handle and direct valve mechanism enable the operator to deliver excellent rates of inflation in comfort, which in turn provides customers with extended tyre life, increased fuel economy and improved safety for tyre shops, garages, car dealers and transport depots.



Features

- Reduced usage times - driven by the simplicity of use and clear display
- Reduced cost of ownership - long product life
- Guaranteed accuracy - individually tested and certified
- Ceramic sensor - for long life accuracy
- Modern, lightweight and shock resistant construction
- Over-pressure warning if pressure exceeds 12 bar / 174 psi / 1200 kPa
- Long battery life with low battery warning light



Part Number	Hose Length	Tyre Valve Connection	Calibration
DAC1A03	0.53 m / 21 in	Twin hold-on	0-174 psi
DAC1A06	2.7 m / 9 ft	Twin clip-on	0-174 psi
DAC1A08	1.8 m / 6 ft	Euro clip-on	0-174 psi
DAC1C03	0.53 m / 21 in	Twin hold-on	0-12 bar
DAC1C06	2.7 m / 9 ft	Twin clip-on	0-12 bar
DAC1C08	1.8 m / 6 ft	Euro clip-on	0-12 bar
DAC1D03	0.53 m / 21 in	Twin hold-on	0-12000 kPa
DAC1D08	1.8 m / 6 ft	Euro clip-on	0-12000 kPa

German approvals: PTB 8.08/06.04

ACCURA 5 AVIATION TYRE INFLATOR

The ACCURA 5 is PCL's premium high pressure digital tyre inflator and its latest design for precise measurement in commercial high pressure applications such as aviation. Building on its worldwide reputation for fast, accurate and trouble-free inflation, the market-leading ACCURA 5 features a clear digital readout, metal inlet and outlet valves, metal internal fittings and strong engineering plastics to cope with both high pressure and high usage applications, and can inflate using nitrogen, air or other gases from 3 to 319 psi.

Features

- Built in metal components and engineered plastics to withstand the high pressures
- Brass inlet and outlet valves
- Individually tested and supplied with test certificate
- Low battery warning indicator

Part Number	Hose Length	Tyre Valve Connection	Calibration
DAC5A01	x2 2 m 4G1 Hydraulic Oil Resistant Armoured Hose	8v1 Screw-on and 12v1 Screw-on	3-319 psi



PRESSURE UP TO » 319 PSI



Couplings & Adaptors

Hose

Hose Fittings

Tyre Inflation Equipment

Tyre Care

Nitrogen Equipment

Workshop Equipment

Air Tools

Air Tool Accessories



DIGITAL HANDHELD INFLATORS

Couplings & Adaptors

Hose

Hose Fittings

Tyre Inflation Equipment

Tyre Care

Nitrogen Equipment

Workshop Equipment

Air Tools

Air Tool Accessories



Mid-Range Digital Inflator

DTI TYRE INFLATOR

The DTI Tyre Inflator offers excellent value for money and is suitable for all kinds of tyre applications, with its ability to inflate up to 170psi making it ideal for professional workshops.

Simple to operate, the hand trigger inflate and thumb-operated deflate button enable the user to inflate tyres quickly and accurately. For low visibility areas, a backlight furthers illuminates the LCD display, which incorporates a battery level indicator. The gauge itself features an auto power off function to preserve battery life. Each gauge is individually serialised and supplied with a calibration certificate traceable to international standards. The DTI is PCL's "better", mid-range alternative to the premium ACCURA 1 and makes entry level electronic inflation available to all.

Features

- Large, easy to read LCD display with backlight and auto power off
- Reliable accuracy (+/- 1 psi up to 60 psi, then 2 psi up to 150 psi) with individual testing and certification
- psi, bar & kpa units of pressure selectable by button
- Easy and cost effective to use with low and simple maintenance
- Long battery life with battery level indicator

Part Number	Hose Length	Tyre Valve Connection	Calibration
DTI08	1.8 m	Euro clip-on	5-170 psi / 0.34-12 bar / 34-1200 kPa
DTI081	0.5 m	Euro clip-on	5-170 psi / 0.34-12 bar / 34-1200 kPa

PRESSURE UP TO » 319 PSI (22 BAR)



Premium High Pressure Digital Inflator

ACCURA 5 HIGH PRESSURE TYRE INFLATORS

The ACCURA 5 is PCL's premium high pressure digital tyre inflator and its latest design for precise measurement in commercial high pressure applications such as aviation. Building on its worldwide reputation for fast, accurate and trouble-free inflation, the market-leading ACCURA 5 features a clear digital readout, metal inlet and outlet valves, metal internal fittings and strong engineering plastics to cope with both high pressure and high usage applications, and can inflate using nitrogen, air or other gases from 3 to 319 psi.

Features

- Reduced cost of ownership - long product life, high versatility - flexible usage
- Individually tested and supplied with test certificate
- Built in metal components and engineered plastics to withstand high pressure
- Brass inlet and outlet valves
- Long life battery with low battery warning indicator

Part Number	Hose Length	Tyre Valve Connection	Calibration
DAC5C04	1.8 m / 6 ft	Single clip-on	0.2-22 bar
DAC5A04	1.8 m / 6 ft	Single clip-on	3-319 psi

Accuracy complies to: EN12645:2014



DIAL HANDHELD INFLATORS

AIRFORCE II TYRE INFLATOR

The AirForce II is PCL's premium dial handheld tyre inflator, and the latest in its line of high performance mechanical dial inflators. Meeting all the modern needs of an analogue gauge in a busy tyre shop, the sturdy and lightweight design has been further enhanced with a nylon body and a new metal inlet, making the unit as robust as any high performance dial gauge on the market today. Featuring a user-friendly dial display for fast, trouble-free tyre inflation, the AirForce II, with its high performance mechanical dial, boasts industry-standard EC Directive BS EN12645:2014 approvals and certifications for accuracy, reliability and robustness. Official tests have shown the AirForce II to be well above accepted requirements, enabling operators to provide safe, cost-effective and accurate inflation.



Couplings & Adaptors

Hose

Hose Fittings

Tyre Inflation Equipment

Tyre Care

Nitrogen Equipment

Workshop Equipment

Air Tools

Air Tool Accessories

Part Number	Hose Length	Tyre Valve Connection	Calibration
AFG1H03	0.53 m / 21 in	Twin hold-on	0-170 psi / 0-12 bar
AFG1H06	2.7 m / 9 ft	Twin clip-on	0-170 psi / 0-12 bar
AFG1H08	1.8 m / 6 ft	Euro clip-on	0-170 psi / 0-12 bar
AFG1C08	1.8 m / 6 ft	Euro clip-on	0-12 bar
AFG1D03	0.53 m / 21 in	Twin hold-on	0-1200 kPa
AFG1D08	1.8 m / 6 ft	Euro clip-on	0-1200 kPa

Features

- Reduced operating costs - fast inflation and deflation rates
- Reduced cost of ownership - long product life, high versatility - flexible usage
- Guaranteed accuracy - Individually tested and supplied with calibration certificate
- Proven Bourdon Tube with beryllium copper construction for robustness and high shock resistance

Accuracy complies to: EC Directive BS EN12645:2014

ATI TYRE INFLATOR

PCL's latest mid-range mechanical tyre inflator, the ATI, is suitable for tyre shops, garages, car dealers and transport depots. Featuring a simple user-friendly dial display, the ATI enables operators to provide fast, safe, cost-effective and accurate tyre inflation which in turn allows tyre users to reap the rewards of extended tyre life, increased fuel economy and improved safety.

Features

- Modern, lighter weight design
- Direct valve design increasing inflation and deflation rates
- Individually tested and calibration certificate supplied

Part Number	Hose Length	Tyre Valve Connection	Calibration
ATIH08	1.8 m	Euro clip-on	0-170 psi / 0-12 bar
ATIH081	0.5 m	Euro clip-on	0-170 psi / 0-12 bar

ALSO AVAILABLE » For an EC Directive BS EN12645:2014 approved Mechanical Inflator, please specify the premium AirForce II

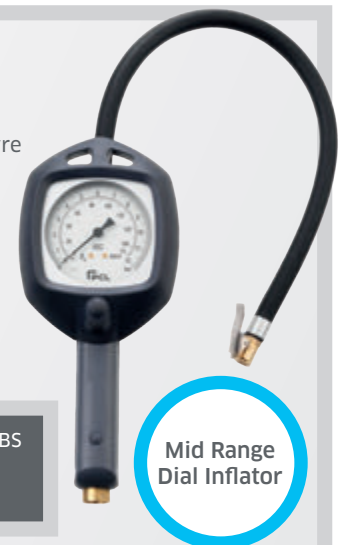



DIAL HANDHELD INFLATORS



ECONOMY ALLOY TYRE INFLATOR

This general purpose tyre inflator, with its durable, alloy body and rubber protected gauge, is ideal for lower volume and non-commercial applications. The ADTG4 Alloy Tyre Inflator features a Euro style valve connector, and comes complete with operating instructions.

Features

- Simple and easy to use
- Ideal for general low volume tyre inflation

Part Number	Hose Length	Tyre Valve Connection	Calibration
ADTG4	0.85 m	Euro clip-on	10-210 psi / 0.7-15 bar



ECONOMY BLOWGUN STYLE TYRE INFLATOR

PCL's Blowgun Style Tyre Inflator is a general purpose tyre inflator with an all alloy body and rubber protected gauge. The LTG01 Blowgun's durable alloy body and Euro style valve connector is most suited to lower volume and non-commercial applications.

Features

- Simple and easy to use
- Ideal for general low volume tyre inflation

Part Number	Hose Length	Tyre Valve Connection	Calibration
LTG01	0.4 m	Euro clip-on	0-174 psi / 0-12 bar

FOOTPUMPS

FOOTPUMPS

PCL's Footpumps are gauge-calibrated models with an easy to read dial. The all steel construction provides extra strength, and the barrel is pressure-sealed to prevent leakage. Supplied with adaptors for airbeds, cycle valves and footballs, the footpump has a sturdy, anti-slip pedal.

Features

- Steel construction for added strength
- Barrel pressure sealed to prevent leakage

Part Number	Barrel	Calibration
FP4H02/3	Single	0-100 psi / 0-7 bar
FP7H02/3	Double	0-100 psi / 0-7 bar



Supplied with various adaptors

Couplings & Adaptors

Hose

Hose Fittings

Tyre Inflation Equipment

Tyre Care

Nitrogen Equipment

Workshop Equipment

Air Tools

Air Tool Accessories



TYRE VALVE CONNECTORS

TYPES OF TYRE VALVE CONNECTORS

It is important when purchasing connectors to specify whether a closed or open-end type is required.

An **open-end connector** has black handles and a pin which unseats the tyre's valve. This is the most commonly used type of connector and is suitable for PCL's MK4 Tyre Inflator, wall and portable gauges.

A **closed end connector** features red handles and is employed when air is supplied directly from a main air line (i.e. compressor or air receiver). A non-return valve unseats on connection to the tyre's valve, allowing air to flow into the tyre.



Couplings & Adaptors

Hose

Hose Fittings

TWIN HOLD-ON CONNECTORS

BEST SELLER

PCL's connectors have an excellent reputation for durability, accuracy and superb sealing qualities, setting the standard for hold-ons. Using only the best components, with appropriate tests in place to evidence high quality and performance, PCL offers the full range to meet the needs of the modern tyre shop and workshop, from the standard twin hold-on to the short stem and angled stem.

Features

- Suitable for inflation of twin tyres
- Choice of stem length
- Colour coded handles – black for open end and red for closed end

Part Number	Description	Valve Style	Inlet Size
CO1A03	Long stem	Open end	Rp 1/4
CO1B03	Long stem	Closed end	Rp 1/4
CO5A03	Short stem	Open end	Rp 1/4
CO5B03	Short stem	Closed end	Rp 1/4
CO15A01	Angled stem	Open end	6.35 mm (1/4 in)



Tyre Inflation Equipment

Tyre Care

Nitrogen Equipment

TWIN CLIP-ON CONNECTORS

PCL's Twin Clip-on Connector is suitable for the inflation of twin tyres, and allows the tyre operator flexibility of use for workshop applications. Clipping itself to the tyre valve for additional safety, this connector is designed for performance in intensive environments, and is available in both open and closed valve styles.

Features

- Clips onto tyre valve to allow operator to work away from tyre
- Colour coded handles – black for open end and red for closed end
- Suitable for inflation of twin tyres
- Suitable for use in tyre shops

Part Number	Valve Style	Inlet Size
CO3A03	Open end	Rp 1/4
CO3B03	Closed end	Rp 1/4

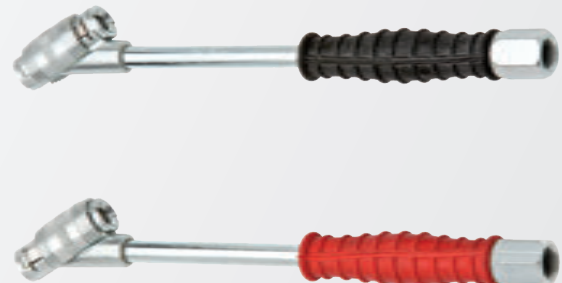

Workshop Equipment

Air Tools

Air Tool Accessories



TYRE VALVE CONNECTORS

SINGLE CLIP-ON CONNECTORS

Once the PCL Air Connector is on, it stays on!



Features

- Does not bleed air - once the PCL Air Connector is on, it stays on!
- Simple but effective thumb push button - quickly releases the tyre valve, reducing non-value added time
- Simply turn clockwise to achieve even more grip
- Highly reliable - has undergone extensive in house and external testing
- Suitable for use in garages, workshops and tyre shops

Part Number	Tyre Valve Connection	Thread Type
CH2K01	Straight single clip-on connector	For 7.9mm / 5/16" bore hose
CH2H01	Straight single clip-on connector	For 6.35mm/ 1/4" bore hose
CH2A01	Straight single clip-on connector	Rp 1/4 Inlet
CH4A01	Angled single clip-on connector	Rp 1/4 Inlet

PCL's new, improved Single Clip-on Connector has been designed to bring the connector range into the 21st century. Extensive in-house and external testing has shown the enhanced product to be as robust and reliable as ever. Manufactured using the finest zinc alloy, aluminium and brass, the Single Clip-on Connector boasts a vice like grip, and is easily operated with a simple but effective thumb push button which quickly releases the tyre valve, saving time and resources.

The advanced range includes standard, straight connectors, and also 90-degree connectors for those difficult to reach valves - such as those on today's bigger, more intricately designed alloy/steel wheels which are difficult to reach by hand. Available with both hose tail fitting and female threaded versions.

SINGLE CLIP-ON CONNECTORS - CLOSED END

After 40 years of service, PCL's closed end Single Clip-on Tyre Valve Connectors are still a popular choice in tyreshops.

Features

- Clips onto tyre valve allowing operator to work away from tyre
- Suitable for use in tyre shops

Part Number	Tyre Valve Connection	Thread Type
C02F03	Single clip-on	4.75 mm / 3/16 in
C02J03	Single clip-on	6.35 mm / 1/4 in

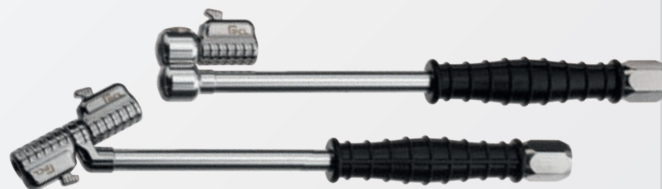

SWIVEL CLIP-ON CONNECTORS

Now available with an ergonomic handle, these Swivel Clip-on Connectors are easy to operate and feature a vice-like grip.

Part Number	Tyre Valve Connection	Thread Type
CH3A01	Twin swivel clip-on connector	Rp 1/4
CH3A02	Single swivel clip-on connector	Rp 1/4

EURO STYLE CONNECTORS

PCL's Euro style connectors are built to meet the rigours and requirements of the modern tyre shop, providing excellent life and reducing leaks.



Features

- Clips onto tyre valve to allow operator to work away from tyre
- Suitable for use in tyre shops

Part Number	Tyre Valve Connection	Valve Style	Inlet Size
C08E72	Euro style clip-on	Open end	4.75 mm / 3/16 in
C08H72	Euro style clip-on	Open end	6.35 mm / 1/4 in
C08T73	Euro style clip-on	Open end	Rp 1/4
C08U73	Euro style clip-on	Closed end	Rp 1/4

Couplings & Adaptors

Hose

Hose Fittings

Tyre Inflation Equipment

Tyre Care

Nitrogen Equipment

Workshop Equipment

Air Tools

Air Tool Accessories



TYRE VALVE CONNECTORS



CO7Q02 CO10H03 CO13A71

CO11A03

LARGE BORE CONNECTORS

PCL's Large Bore Clip-on Connectors, also known as EM connectors, are designed for tyres with large bore valves such as Earthmover tyres, and are available in both closed and open end valve styles.

Part Number	Tyre Valve Connection	Valve Style	Inlet Size
CO7Q02	12v1 clip-on	Closed end	Rc 1/4 female
CO7P02	12v1 clip-on	Open end	Rc 1/4 female
CO10H03	12v1 screw-on	Open end	6.35 mm / 1/4 in
CO10P03	12v1 screw-on	Open end	Rp 1/4
CO11A03	12v1 in-line hold-on	Open end	Rp 1/4
CO13A71	Euro style 12v1 clip-on	Open end	6.35 mm / 1/4 in



CO9P03

CO12A03

OTHER SPECIALIST CONNECTORS

PCL's specialist connectors covering varying applications include screw-on connectors for extra security during inflation, and the ever-popular in-line connector - the CO12.

Part Number	Tyre Valve Connection	Valve Style	Inlet Size
CO9H03	8v1 screw-on	Open end	6.35 mm / 1/4 in
CO9P03	8v1 screw-on	Open end	Rp 1/4
CO12A03	8v1 in-line hold-on	Open end	Rp 1/4

TPMS FRIENDLY FLEXI TYRE VALVE CONNECTOR

PCL's premium TPMS friendly FLEXI Tyre Valve Connector prevents damage and breakages to delicate TPMS valve stems where pressure causes them to snap, for example when using retractable air hose reels at petrol filling stations.

Features

- Prevents connector being used as a lever on direct TPMS valve stems which causes breakages
- Allows easy reach to Motorcycle tyre valves with large brake discs
- Retro-fits to existing petrol filling station air towers and other tyre inflation locations where reels may cause issue
- 8" length allows for greater hose flexibility



Part Number	Tyre Valve Connection	Valve Style	Inlet Size
CO20A01	Twin hold-on	Open end	Rp 1/4
CO21A01	In-line hold-on	Open end	Rp 1/4

THUMB-LOCK CONNECTOR

PCL's original Thumb Lock Tyre Valve Connector is a simple and effective way to establish a good sealing grip on a Schrader car or bicycle tyre valve, and has become a blueprint for competitors.



Features

- Ideal for use with PCL footpumps and other thumb lock applications

Part Number	Tyre Valve Connection	Valve Style	Inlet Size
FPA02	Thumb-lock	Open end	4.75 mm / 3/16 in

TYRE VALVE TOOLS

VALVE CORE RETRACTING TOOL

PCL's 2-in-1 Valve Core Retracting Tool is designed for the safe installation and removal of tyre valve cores during the inflation of commercial vehicle tyres. This handy clip-on tyre valve connector vastly reduces inflation / deflation time and eliminates the risk of serious injuries from "flying" valve cores.

Features

- Clear body allows operator to see when valve core is fully retracted

Part Number	Inlet Size	Tyre Valve Connection
CRT001	6.35 mm / 1/4 in	Euro style clip-on
CRT002	6.35 mm / 1/4 in	Clip-on



Couplings & Adaptors

Hose

Hose Fittings

Tyre Inflation Equipment

Tyre Care

Nitrogen Equipment

Workshop Equipment

Air Tools

Air Tool Accessories

TYRE CARE



Carrying out regular tyre checks is an essential part of taking care of your car. Not only is it vital for increasing safety but it can also save you money through reduced petrol consumption and lower emissions. That's why PCL offers a comprehensive range of high-quality tyre care tools which allow you to check your tyres anytime and anywhere. This handy selection covers all glove box essentials, including traditional pencil style tyre pressure gauges, DVSA-approved tyre tread depth gauges, and digital tyre pressure and tread depth gauges.

BEST SELLER

PENCIL STYLE TYRE PRESSURE GAUGES



Page 56

BEST SELLER

TYRE TREAD DEPTH GAUGE



Page 60

BEST SELLER

DIGITAL TYRE PRESSURE & TREAD DEPTH GAUGE



Page 61



Pencil Style Tyre Pressure Gauges

Page 56



Pencil Style Service Tyre Pressure Gauges

Page 57



Universal Service Gauges

Page 57



Twin Head Tyre Gauge

Page 57



Dial "TyreCheck" Pressure Gauge

Page 58



Digital Tyre Pressure Gauge

Page 58



Digital Tyre Pressure Gauge Kit

Page 59



Tyre Tread Depth Gauge

Page 60



Digital Tyre Tread Depth Gauge

Page 60



Tyre Safety Pack

Page 61



Digital Tyre Pressure & Tread Depth Gauge

Page 61



Tyre Valve Removal Tool

Page 62



Calibration Test Unit

Page 62



Master Pressure Gauge

Page 62

Tyre Care



TYRE PRESSURE GAUGES

PENCIL STYLE TYRE PRESSURE GAUGES

BEST SELLER

This pocket-sized pencil-style tyre pressure gauge provides the convenience and confidence that it won't let you down. Unlike digital gauges, the traditional analogue gauge doesn't require batteries, so can be used at any time, in any conditions. It also incorporates a self-adjusting friction device which enables the pressure to be accurately read when the tyre pressure gauge is removed from the tyre valve, and a positive sealing washer to ensure reliability.

For additional convenience, the gauge is available with either an angled head, designed to fit on to the valve at 90°, or an in-line head for when direct access to the tyre valve is required.

Features

- Includes integral pocket clip and removable protective cap
- Complies with BS EN12645:2014
- Calibration: 6-50 psi / 0.5-3.4 bar
- Resolution: 1 psi / 0.1 bar
- Accuracy: +/- 2 psi

Available with angled head which is designed to fit onto the valve at 90°, or an in-line head perfect for when direct access to the tyre valve is required.



TPG20H17

TPG1H07



Part Number	Head Type	Packaging
TPG1H07	Angled	Blister packed
TPG1H17	Angled	Storage Tin
TPG20H07	In-line	Blister packed
TPG20H17	In-line	Storage Tin

CHECKING TYRE PRESSURE - WHY IT MATTERS AND HOW TO DO IT



Keeping your tyres correctly inflated is vital for safety and can also help ensure an even wear rate, leading to longer tyre life and reduced petrol consumption. Checking tyre pressure doesn't take long, all you need is an accurate gauge and a few minutes each month and before long journeys.

1. Tyres must be cool to take accurate readings, so allow around three hours to cool.
2. Check the manufacturer's recommended tyre inflation levels. You will find this information in the form of a chart in the owner's manual or on the driver side door frame. This will show the correct tyre pressure, marked in PSI and BAR.
3. Unscrew the dust caps on your tyres. Make sure to keep them somewhere safe!
4. Press the gauge on to one of the valves. You'll hear a little hiss of air.
5. Check the measurement on the scale and compare to the recommended levels on the chart. If the air pressure reading is below the recommended setting for your vehicle, add more air until you have reached the correct pressure. If your tyres are overinflated, simply remove the amount of air needed for your tyres to reach the recommended pressure.
6. Remove the gauge from the valve quickly to stop air escaping and screw the dust cap back on.
7. Repeat this process for every tyre (including your spare, if you have one!).



TYRE PRESSURE GAUGES

PENCIL STYLE SERVICE TYRE PRESSURE GAUGES

PRESSURE UP TO » 120 PSI (8.2 BAR) 

PCL's service gauges feature a greater calibration range, making them the perfect fit for commercial vehicles. A self-adjusting friction device enables the pressure to be accurately read when the tyre pressure gauge is removed from the tyre valve, whilst a positive sealing washer ensures reliability. Gauges come with an integral pocket clip, and are available with an angled head designed to attach to the valve at 90°, or a twin head for ease of use on vehicles with twin wheels.

Features

- Includes integral pocket clip and removable protective cap
- Complies with BS EN12645:2014
- Calibration: 10-120 psi / 0.8-8.2 bar
- Resolution: 2 psi / 0.2 bar
- Accuracy: +/- 2 psi



Part Number	Head Type	Packaging
TPG3H07	Angled	Blister packed
TPG4H07	Twin	Blister packed
TPG4H17	Twin	Storage Tin

Couplings & Adaptors

Hose

Hose Fittings

Tyre Inflation Equipment

Tyre Care

Nitrogen Equipment

Workshop Equipment

Air Tools

Air Tool Accessories



UNIVERSAL SERVICE GAUGES

PCL's high quality "Made in Sheffield" gauge is suitable for cars and commercial vehicles and is favoured by professional mechanics. Engineered for hard usage over a long period, its high quality mechanism is protected by an extra-large filter. Available with a hard-wearing black vulcanite handle to withstand prolonged use, this durable tool provides accuracy of +/- 2 psi.

Features

- Engineered for hard usage over a long period
- Extra large filter to protect the quality mechanism
- Also available with a black vulcanite handle to withstand continual hard usage
- Calibration: 10-160 psi / 0.8-11 bar
- Resolution: 2 psi / 0.2 bar
- Accuracy: +/- 2 psi

Part Number	Description	Head Type
TPG57H03	Chrome plated tubing with lanyard ring	Twin
TPG60H03	Heavy duty black vulcanite handle	Twin



PRESSURE UP TO » 300 PSI (20 BAR) 

TWIN HEAD TYRE GAUGE

This high quality "Made in Sheffield" twin-head tyre gauge is 100% individually tested and supplied with a calibration certificate. Suitable for use with standard (8v1) and large bore (12v1) tyre inflators within the aviation industry, this sturdy gauge is designed for continual heavy use and is available with a hard-wearing black vulcanite handle.

Features

- Black vulcanite handle to withstand continual hard usage
- Suitable for use with standard (8v1) and large bore (12v1) tyre inflators
- Supplied with calibration certificate
- Calibration: 50-300 psi / 4-20 bar
- Resolution: 5 psi / 0.2 bar
- Accuracy: +/- 5 psi

Part Number	Head Type
TPG54H03	Twin

Also available » RPR1H02 - Reconditioning and recalibration service (including a certificate of conformity)

Full range of tyre inflation equipment



See pages 38-53



TYRE PRESSURE GAUGES

Couplings & Adaptors

Hose

Hose Fittings

Tyre Inflation Equipment

Tyre Care

Nitrogen Equipment

Workshop Equipment

Air Tools

Air Tool Accessories

DIAL "TYRECHECK" PRESSURE GAUGE

Designed for simplicity and convenience of use, the dial-type "TyreCheck" pressure gauge is the professional's choice of dial pressure gauge for fast, clear and accurate readings. Ideal for use in busy workshops, the robust dial gauge features an impact-absorbing rubber outer casing which protects against minor damage providing a longer life expectancy.



Features

- Accurate and easy to read dial gauge
- Impact absorbing rubber outer casing
- Calibration: 0-170 psi / 0-12 bar
- Resolution: 2 psi / 0.1 bar

Part Number	Dial Diameter (mm)	Tyre Valve Connector
DPG1H03	63	Twin hold-on
DPG1H08	63	Twin clip-on
DPG3H03	80	Twin hold-on
DPG3H08	80	Twin clip-on



IDEAL FOR » BUSY WORKSHOPS

DIGITAL TYRE PRESSURE GAUGE

The DTPG8 Digital Tyre Pressure Gauge, provides flexibility along with time and cost-savings. With a 30 second auto power off and large backlit screen for easy reading in dark or low light areas, its swivel head allows easy access to the tyre valve. Designed for simplicity of use, simply press the 'ON' button and the gauge is ready to use, with tyre pressures displayed in a choice of four pressure measurements.



Features

- 4 measurement options - psi, bar, kPa, kg/cm²
- Clear large backlit display with auto power off
- x2 AAA / LR03 batteries supplied
- Supplied with calibration certificate

Part Number	Tyre Valve Connector	Calibration	Resolution	Accuracy
DTPG8	Twin hold-on	0-174 psi / 0-12 bar / 0-1200 kPa / 0-12 kg/cm ²	0.2 psi / 0.01 bar / 1 kPa	+/- 1 %





TYRE PRESSURE GAUGES

DIGITAL TYRE PRESSURE GAUGE KIT

This high pressure digital kit takes PCL's market-leading digital tyre inflation to the next level, building on its worldwide reputation for fast, accurate and trouble-free inflation. Ideal for high pressure applications such as aviation, the gauge features metal inlet and outlet valves, metal internal fittings and strong engineering plastics to cope with both the high pressure and the high usage environments seen in line and base maintenance activities.



PRESSURE UP TO » 319 PSI (22 BAR) ✈️



Features

- Allows pressure to be measured and stored for easy reading
- Includes 2 connector types; 8v1 hold on and 12v1 single in-line hold, interchangeable
- Contained within a sturdy plastic box
- DAC54 is suitable for high pressure environments such as Aviation
- Brass outlet valve with safety blow off valve
- Proprietary software increasing accuracy, fine metering and eliminating the chance of false readings

Part Number	Description	Hose	Tyre Valve Connector	Calibration	Resolution
DAC51A	Full kit with case	0.3 m PVC hose	8v1 twin hold-on and 12v1 in-line	1-174 psi	0.2 psi
DAC51C	Full kit with case	0.3 m PVC hose	8v1 twin hold-on and 12v1 in-line	0.1-12 bar	0.01 bar
DAC54A	Full kit with case and spare battery	0.5m 4G1 hose	8v1 twin hold-on and 12v1 in-line	3-319 psi	1 psi
DAC54C	Full kit with case and spare battery	0.5m 4G1 hose	8v1 twin hold-on and 12v1 in-line	0.2-22 bar	0.1 bar

Other configurations available



Couplings & Adaptors

Hose

Hose Fittings

Tyre Inflation Equipment

Tyre Care

Nitrogen Equipment

Workshop Equipment

Air Tools

Air Tool Accessories



TYRE TREAD DEPTH GAUGES

TYRE TREAD DEPTH GAUGE

BEST SELLER

PCL's "Made in Sheffield" Tyre Tread Depth Gauge is manufactured to stringent quality standards and is DVSA (previously VOSA) MOT centre approved. Easy to read, it provides accurate measurement of tread 1-26mm and features a 1.6mm illegal tyre tread depth mark, allowing the operator to quickly check whether the tyre tread is below legal limits and needs to be replaced.

Features

- Accurate measurement of tread 1-26 mm in 1 mm increments
- 1.6mm illegal tyre tread depth mark
- Department of Transport accepted for MOT testing
- Handy pocket clip



**DVSA
MOT
centre
approved**

Part Number	Calibration	Resolution	Accuracy
TDG16C01	0-25 mm / 0-1 in	0.01 mm / 0.0005 in / 1/64 in	0.2 mm

TYRE TREAD DEPTH

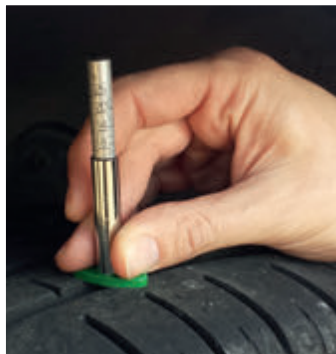

Why is measuring tyre tread depth important?

If tyre tread depth wears below 3mm, ability to grip the road is reduced and stopping distances increase dramatically, therefore checking the measurements at least once a month and before long journeys is vital. Driving with worn tyres is a serious safety risk and can be costly too. In the UK if your tyre is below the 1.6 mm legal limit, you could get a £2,500 fine plus three points on your licence, per tyre.

How to measure your tyre tread depth with a gauge

You can carry out a visual check of the tread wear indicators to assess the levels of your tread depth. These indicators are small raised areas at the bottom of the grooves on your tyres. If the surface of the tread rubber is level with these raised areas, the tyre tread depth is approaching the legal limit and you should have your tyres checked and replaced.

However, using a tyre tread depth gauge will provide a more accurate measurement and is simple to do.

1. Extend the measuring probe on the tread depth gauge as far as it will go.
2. Place the probe into the tread groove, making sure not to place it on the tread wear indicators or any raised surfaces of the tread design. Push down on the gauge's base.
3. Check the measurement is above 1.6mm. If you are using an analogue gauge this will be shown on a scale. If it's digital the reading will be displayed on a screen.
4. Measurements must be taken around the whole circumference of the tyre and across the central three-quarters of the width of the tyre.
5. Repeat the process on every tyre.



DIGITAL TYRE TREAD DEPTH GAUGE

This Tyre Tread Depth Gauge is designed to be straight-forward and simple to use. The battery-operated measurement device features a large, easy-to-read LCD display with three different read settings, and a Zero setting in any position allowing easy zero reset. Made from lightweight, extra-strong carbon fibre composite, the strong and robust housing material ensures a longer life expectancy.

Features

- Made from extra strong carbon fibre composite
- Metric, decimal inch and fraction inch (1/64 in) toggle
- Large LCD display
- x1 SR44 1.5 v battery supplied
- Zero setting in any position

Part Number	Calibration	Resolution	Accuracy
DTDG1D04	0-25 mm / 0-1 in	0.01 mm / 0.0005 in / 1/64 in	0.2 mm

Couplings & Adaptors

Hose

Hose Fittings

Tyre Inflation Equipment

Tyre Care

Nitrogen Equipment

Workshop Equipment

Air Tools

Air Tool Accessories



TYRE PRESSURE & DEPTH GAUGES

DIGITAL TYRE PRESSURE & TREAD DEPTH GAUGE

BEST SELLER



PCL's 3-in-1 Digital Tyre Pressure and Tread Depth Gauge features a large backlit screen with stylish blue light and 90 second auto power off - making it ideal for easy reading at night and in dark workshops or low light areas. Designed for ease of use, the display will flash to indicate an illegal tyre tread depth warning below 1.6 mm, allowing the operator to quickly check whether the tyres need to be replaced.

**Awarded
BEST BUY
2020 by Auto
Express**



Features

- Illegal tyre tread depth warning - display will flash if the reading is 1.6 mm or less
- Large backlit screen and blue light - ideal for use at night or dark workshops
- Auto power off
- x1 CR2032 3 v battery supplied

Part Number	Calibration	Resolution	Accuracy
DTPG7	2-100 psi / 0.15-7 bar & 15-700 kPa & 0-15 mm	0.1 psi / 0.01 bar / 1 kPa & 0.01 mm / 0.001 in	+/- 1.5% & +/- 0.2 mm

TYRE SAFETY PACK

PCL's handy Tyre Safety Pack comprises a pencil-style tyre pressure gauge and a tyre tread depth gauge stored in a durable and reusable foam-packed metal case. The traditional but accurate tyre pressure gauge is available with either an angled or in-line head, and the "Made in Sheffield" tyre tread depth gauge is DVSA-approved for MOT testing with a 1.6mm mark.

Features

- A positive sealing washer ensures reliability
- Self-adjusting friction device
- DVSA approved for MOT testing
- Accurate measurement of tread 1-26 mm
- 1.6 mm illegal tyre tread depth mark

Part Number Kit Contents

TSP1T15 TPG1 & TDG16C01

TSP20T15 TPG20 & TDG16C01



TSP20T15

TSP1T15

**Awarded
BEST BUY
2019 by Auto
Express**



TEST EQUIPMENT

CALIBRATION TEST UNIT

Lightweight and portable, PCL's TE3 Calibration Test Unit is used to check the calibration of all types of tyre inflation equipment, and is supplied with a calibration certificate. The rechargeable TE3 unit is housed in a robust and durable protective case to prevent damage, whilst the 21mm backlit LCD provides clearer and more concise readings than those of an analogue gauge.

Features

- 4 litre receiver manufactured in accordance with 2009/105/EC
- Supplied with calibration certificate
- Resettable zero point
- Battery powered with battery charger included
- Accuracy class: 1/4 of EN12645:2014

Part

Part Number	Calibration	Resolution
TE3	0-12.2 bar / 0-1220 kPa / 0-176 psi	0.01 bar / 1 kPa / 0.1 psi

Battery charger included



MASTER PRESSURE GAUGE

PCL's "Made in Sheffield" Master Pressure Gauge is highly regarded for its reliability and accuracy, and offers such longevity it is often handed down through generations. Designed for checking the accuracy of on-site gauges, the Master comes protected in a solid wooden box and is a firm favourite amongst tyre fitters, commercial fleet operators and the emergency services.

Features

- Designed for checking the accuracy of on-site gauges
- Protected in a solid wooden box with moulded tray
- Supplied complete with calibration certificate
- Complies to: BS EN 12645:2014

Part

Part Number	Calibration	Accuracy
TE60H01	10-160 psi / 0.8-11 bar	+/- 0.1 bar / 1 psi



TYRE TOOLS

TYRE VALVE REMOVAL TOOL

The versatile 4-in-1 Tyre Valve Removal Tool is a hard-wearing and valuable piece of workshop equipment. Manufactured in zinc-plated steel for longevity of life, this handy tool is capable of tackling four different valve-related tasks, including rethreading the external and internal part of the valve stem, removing the valve core, and extracting a damaged valve core.

Features

- Manufactured with case-hardened mild steel and a zinc-plated finish



Part

Part Number	Description
TVT01	4-in-1 Tyre Valve Tool

Couplings & Adaptors

Hose

Hose Fittings

Tyre Inflation Equipment

Tyre Care

Nitrogen Equipment

Workshop Equipment

Air Tools

Air Tool Accessories



Expertise in design and innovation has seen PCL establish itself as the brand to use in the most testing of tyre inflation and pneumatic applications.

As the worldwide market leader in equipment for tyre checking and inflation, PCL is a common sight in workshops and tyre shops, aircraft service centres and forecourts.

PCL offers the highest quality, most reliable and cost-effective equipment for fast and accurate tyre inflation, ranging from handheld analogue units, to the high-tech ACCURA electronic range - meeting user needs whatever the application or personal preference.

Explore our latest range of tyre inflation equipment.

See pages 38-53

Couplings & Adaptors

Hose

Hose Fittings

Tyre Inflation Equipment

Tyre Care

Nitrogen Equipment

Workshop Equipment

Air Tools

Air Tool Accessories

NITROGEN EQUIPMENT



PCL continues to set the pace with its nitrogen product range, which combines the latest in high performance digital technology with cost-effective delivery of N₂.

Designed to cover all nitrogen inflation applications, from fast-fit tyre centres to off road vehicles and industrial gas requirements in very demanding environments, PCL's advanced equipment is user-friendly and reliable, providing the highest levels of accuracy.

NEXUS N72 MOBILE NITROGEN GENERATION AND GAS DELIVERY CARTS

Page 66



COMPREHENSIVE RANGE OF FIXED NITROGEN TOWERS

Page 67



NITROGEN INFLATION EQUIPMENT

Why Nitrogen?

Using nitrogen as an alternative to air provides enhanced handling, improved fuel efficiency, extended tyre life, and most importantly, increased safety for all car users.

Nitrogen has the ability to:

- **Reduce pressure loss**
Nitrogen has a larger molecular structure than oxygen, so it migrates through the rubber tyre wall much more slowly, thereby reducing the speed of pressure loss.
- **Prevent unwanted pressure changes**
Nitrogen is a dry gas which reduces energy build up inside the tyre on long journeys. This prevents unwanted pressure increases and uneven tyre wear.
- **Limit tyre and wheel rim wear**
Nitrogen is a dry gas which means it doesn't oxidise (causing rust) or react with materials it comes into contact with, such as the inner tyre wall and inner wheel rim.
- **Decrease fire hazard**
Fire needs oxygen. Removing and replacing it with completely inert nitrogen reduces the potential for tyre fires in hazardous environments

For the road user nitrogen inflation means:

- **Decreased fuel consumption**
By reducing the migration of gas through a tyre it will stay inflated correctly for longer. This prevents extra rolling resistance on the engine and subsequent increase in fuel use.
- **Reduced tyre wear**
Tyres that stay inflated to the correct pressure for longer will last for an extended period. If the correct amount of rubber is in contact with the road surface the tyre tread will wear at a much slower rate.

How does nitrogen inflation benefit the tyre service provider?

- **Raises business profile**
Offering nitrogen as a service provides customers with additional benefits, keeping your business competitive
- **Safety**
Correct tyre inflation improves grip, maximises vehicle stability and ultimately road safety.
- **Increases customer retention**
Offer free nitrogen top-ups for life once the customer has paid for a conversion and keep them coming back!





Couplings & Adaptors

Hose

Hose Fittings

Tyre Inflation Equipment

Tyre Care

Nitrogen Equipment

Workshop Equipment

Air Tools

Air Tool Accessories

NITROGEN GENERATORS

How do Nitrogen Generators work?

The air we breathe contains 78% nitrogen, 21% oxygen and 1% other gases. Pure nitrogen has a number of properties which are beneficial to commercial applications. For example, its dry properties prevent oxidation in the manufacturing process, whilst its inert properties remove the potential for fire in dangerous environments. This makes it a very useful gas for industry. Where tyre inflation is concerned, the large molecular structure of nitrogen slows down the rate of pressure loss in inflated rubber tyres.

PCL's nitrogen generators contain advanced filtration to remove oxygen and other unwanted gases from compressed air, delivering a high purity nitrogen mix. Our advanced portfolio of UK-manufactured products covers all requirements and flow rates, from battery-powered mobile systems for tyre inflation in workshops/tyre shops, to fixed systems for industrial and retail applications.

WORKSHOP / TYRE SHOP UNITS

ALSO AVAILABLE » FOR EM/OFF ROAD TYRES CONTACT PCL FOR INDIVIDUAL REQUIREMENTS



The compact, mobile NEXUS N72 is a new addition to PCL's nitrogen generation offering, superseding the original NEXUS range. The "Made in Sheffield" system combines PCL's world-renowned digital pressure control technology with modern, membrane nitrogen generation technology to deliver high purity nitrogen quickly and quietly.

This innovative nitrogen generation and gas delivery cart includes additional features, offering real end-user benefits. Designed with complete flexibility and mobility in mind, the NEXUS N72 is just half the size of comparable units, and is suitable for all types of tyre shop and industrial applications. Powered by a rechargeable battery, the unit can be moved easily around the workspace with minimal fuss.



Part Number	Tyre application	Flow rate @ 10 bar	Min feed air required
N72SAIC24	4 x Car	5 m ³ /h (83 l/min)	8 cfm (226 l/min)
N72SAIC34	4 x Car, 4 x Van and 1 x Truck	10 m ³ /h (167 l/min)	16 cfm (452 l/min)
N72SAGC1	1 x Car	3 m ³ /h	5 cfm (141 l/min)
N72SAGC2	1 x Van	5 m ³ /h	8 cfm (226 l/min)
N72SAGC3	1 x Truck	10 m ³ /h	16 cfm (452 l/min)



NITROGEN GENERATORS

INDUSTRIAL UNITS

PCL's fixed membrane units are the perfect solution for customers looking for a simple, cost-effective source of nitrogen generation. These systems can deliver up to 97% purity in a range of pressures and flow rates up to 40m³/h. Ideal for filling nitrogen storage vessels, creating inert environments in manufacturing processes, or for simply pressurising any vessel with nitrogen, PCL's comprehensive range provides an option for all requirements.



Couplings & Adaptors

Hose

Hose Fittings

Tyre Inflation Equipment

Tyre Care

Nitrogen Equipment

Workshop Equipment

Air Tools

Air Tool Accessories

Part Number	Max Flow rate @ 10 bar 95%	Min feed air required
N90SSGC1	3 m ³ /h (50 l/min)	5 cfm (141 l/min)
N90SSGC2	5 m ³ /h (83 l/min)	8 cfm (226 l/min)
N90SSGC3	10 m ³ /h (167 l/min)	16 cfm (452 l/min)
N95SSGC4	20 m ³ /h (333 l/min)	32 cfm (904 l/min)
N95SSGC5	30 m ³ /h (500 l/min)	48 cfm (1356 l/min)
N95SSGC6	40 m ³ /h (666 l/min)	64 cfm (1808 l/min)

Flow rates up to 40m³/h

ALSO AVAILABLE » BULK TURNKEY NITROGEN DELIVERY SYSTEMS, PLEASE CONTACT PCL

NITROGEN PURITY ANALYSER

The PCL Nitrogen Analyser is easy and convenient to use, providing the actual nitrogen percentage in vessels or tyres. Most other systems on the market show the oxygen levels and require a manual calculation to work out the percentage of nitrogen purity.

Features

- Compact and ergonomic design
- One button operation for simple use
- Auto power off battery saving system
- Error code and diagnostics

Part Number	Description
N2A001	Nitrogen Analyser
N2AS001	Replacement Sensor



WORKSHOP EQUIPMENT



This is a range of products no workshop should be without. PCL's comprehensive portfolio of equipment covers all needs, from the complete range of FRL air treatment to a wide variety of blowguns, and includes a selection of HVLP compliant spray guns suitable for most light and medium viscosity spray applications.

BEST SELLER



EXPEL 30 Point of Use Compressed Air Filter

Page 71



Dropout® Water Separator with Built-in Auto-drain

Page 72



Dropout® Water Separator

Page 72



Dropout® Water Separator - Stainless Steel

Page 72



Dropout® Auto-drain

Page 72



Filter-Regulator & Lubricator

Page 73



Filter-Regulator

Page 73



Filter

Page 73



Lubricator

Page 73



Regulator

Page 73



Pressure Gauges

Page 73



Economy Air Treatment

Page 74



In-Line Filter

Page 74



In-Line Lubricator

Page 74



Oil Lubricated Direct Drive Compressors

Page 76



Belt Driven Compressors

Page 76



Compressor Oil

Page 76



Standard Ergo Extreme Blowguns

Page 78



2 Bar Auto Safety Ergo Extreme Blowguns

Page 78



Low Noise Ergo Extreme Blowgun

Page 78



Turbo Ergo Extreme Blowgun

Page 78



Aircurtain Ergo Extreme Blowgun

Page 78



Standard Ergo Blowguns

Page 79



2 Bar Auto Safety Ergo Blowguns

Page 79



Low Noise Ergo Blowgun

Page 79



Turbo Ergo Blowgun

Page 79



Aircurtain Ergo Blowgun

Page 79



Standard Safety Nozzle Blowgun

Page 80



Plastic Blowgun

Page 80



Pistol Grip Blowgun

Page 80



Palm Blowguns

Page 80



Economy Palm Blowgun

Page 80



Blowgun Nozzles

Page 81



AirVac

Page 80

























HVLP Spray Guns

Page 81

Workshop Equipment

WORKSHOP EQUIPMENT



Couplings & Adaptors					
Hose	Lite Spray Guns Page 81	Cleaning (Paraffin) Gun Page 82	Sandblasting Gun Page 82	Body Gun with Extension Probe Page 82	Underseal Gun Page 82
Hose Fittings					
Tyre Inflation Equipment	Water Dispenser Page 82	Brake Bleeders Page 83	Oil Extractor Page 83	Bench Top Hose Reels Page 84	Workshop Pro Hose Reels Page 84
Tyre Care			NEW 		
Nitrogen Equipment	Workshop Prestige Hose Reels Page 84	Retracta Spring Rewind Hose Reels Page 83	Hand Pump K 10 C Page 85	Hand pump OK 9 B Page 85	Hand rotary pump KP 01 Page 86
Workshop Equipment					
Air Tools	Hand crank pump HK 07 Page 86	Hand Pump For AdBlue® Page 86	PCP 250 Hand Pump for Chemicals Page 86	High-pressure Two Handed Lever-type Grease Gun Page 87	Lever-operated Grease Guns Page 87
Air Tool Accessories		BEST SELLER 			
	Tankquick Eco Page 87	FMT 3 Flow Meter Page 88			

AIR TREATMENT

Why use an air treatment unit?

Compressed air systems must be kept clean and dry to ensure continued reliability. Precise pressure control also keeps pneumatic systems operating efficiently. Unregulated, unfiltered, unlubricated air pressure can increase equipment wear, leading to reduced tool life and increased costs.

Filter, Regulator and Lubricators (FRLs) ensure each tool receives a clean, lubricated supply of compressed air at the ideal pressure for optimum performance. Units should be mounted as close to the tool as possible - preferably right where the tool hose connects to the system - and checked regularly.

How to choose the correct air treatment unit

Environment

The unit must be designed and constructed from appropriate material to withstand temperature and climate.

Lubrication

For frequently used tools like impact wrenches and ratchets, a lubricator is required and must always be fitted at the final stage downstream on the air supply after any filtration. In-line lubricators such as the INL6 can be connected on the tool or hose itself.

A fitted lubricator is not always needed, for example if only one air output is available. Also, some tools, including digital tyre inflators and spray equipment, require little or no lubrication, and mechanical inflators may only need monthly lubrication. Therefore, a frequent lubricator is not necessary and may cause lack of performance. Simply oil the relevant tools manually using general air tool oil.

Airflow and port size

FRL units must be properly sized to match the required air flow. Significant increases in flow rates can be achieved using larger ports, but changing port size within a system can affect the fine tuning to flow rate, which may be more convenient.

Always refer to the equipment manufacturer's recommendations and select an FRL with an air flow capacity greater than the tool's requirements.

Filtration level

When considering the level of filtration required, you must factor in the unit's micron rating. Most industrial equipment and tools like impact wrenches only need 10-micron filtration, whilst more-sensitive components and instruments typically demand 5-micron filtration. Food, beverage and pharmaceutical applications routinely demand even finer filtration. Ask the equipment manufacturer for exact filtration requirements.

Don't opt for a finer filter than necessary. Smaller micron-rated filters have higher pressure drops across the filter, so opting for a 5-micron filter when a 40-micron unit is enough will increase energy consumption and equipment wear, leading to higher operating and maintenance costs.



For more helpful product advice, visit www.pclairtechnology.com/support

EXPEL AIR TREATMENT

EXPEL 30 POINT OF USE COMPRESSED AIR FILTER

TESTED TO » ISO 12500 - PART 3 & 4 STANDARD

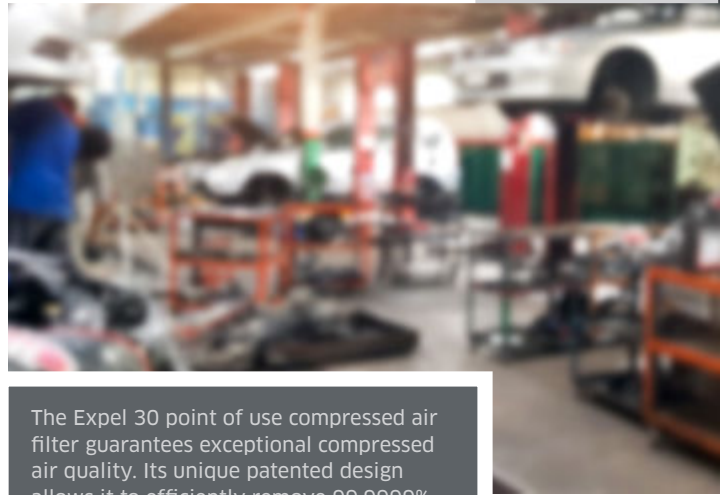

The Expel 30 point of use compressed air filter guarantees exceptional compressed air quality. Its unique patented design allows it to efficiently remove 99.9999% of liquid, oil, water and removes other contaminants down to 1 micron when installed.

The stainless-steel grade 304 unit can be easily dismantled for servicing and cleaning. The auto-drain supplied features a clear bowl for visibility of drain operation.

Expel 30 is suitable for automotive workshop environments where high levels of condensate are frequently experienced.

Features

- Cleanable, reusable compressed air filter
- Removes 99.9999% all liquid water, oils, and filters particulates down to 1 micron
- No increase in pressure drop caused by contaminated filters
- Pressure indicator as standard
- Instantaneous recovery from pulsed flows or stop start
- Supplied with auto-drain



Part Number	Port Size (in)	Maximum Inlet Pressure	Maximum Flow Rate
Expel30	1/2 or 3/4 BSPT	15 bar / 217 psi	850 l/min / 30 cfm

Couplings & Adaptors

Hose

Hose Fittings

Tyre Inflation Equipment

Tyre Care

Nitrogen Equipment

Workshop Equipment

Air Tools

Air Tool Accessories



Couplings & Adaptors

Hose

Hose Fittings

Tyre Inflation Equipment

Tyre Care

Nitrogen Equipment

Workshop Equipment

Air Tools

Air Tool Accessories

DROPOUT® AIR TREATMENT

Dropout® offers an extremely high performance all-in-one solution. Its unique patent design allows the unit to efficiently remove liquid water, oil and other contaminants down to 1 micron at a wide range of flow rates without mains power or costly replacement filter elements.

Recommended for use where there is a high concentration of water in the air supply, Dropout® units are frequently used in paint and refinish environments as an alternative to dryers, where moisture-free air is essential.

Features

- Guaranteed 99.9999% liquid (water & oil) and 99% solid particulate removal
- Particulate removal to 1 micron
- Low maintenance and cost of ownership
- No increase in pressure drop caused by blocked filters
- Instantaneous recovery from pulsed flows or stop start



CONFORMS TO » ATEX MARK EX II 2G IIC T6 GB

DROPOUT® WATER SEPARATOR

The unique, patent protected 3/4" Dropout® Water Separator is sealed for life in aluminium housing. The unit comes complete with a wall bracket and drain valve for manual drainage.



Part Number	Port Size (in)	Maximum Inlet Pressure	Maximum Flow Rate
PDO600A	3/4 BSPT	16 bar / 232 psi	1000 l/min / 35.3 cfm

DROPOUT® WATER SEPARATOR WITH BUILT-IN AUTO-DRAIN

Exceptional compressed air quality is guaranteed with this 1/2" Compact Dropout® unit, which is used as an in-line point of use liquid water separator and contaminant remover.

The unique multi-stage compressed air filter features a built-in auto drain, and once fitted is maintenance free.



Part Number	Port Size (in)	Maximum Inlet Pressure	Maximum Flow Rate
PDO300PA	1/2 BSPT	16 bar / 232 psi	283 l/min / 11 cfm

DROPOUT® WATER SEPARATOR - STAINLESS STEEL

The sealed for life Stainless Steel Grade 304 Dropout® Water Separator is available in a range of port sizes and flow rates. Comes complete with a wall bracket and drain valve for manual drainage.



Part Number	Port Size (in)	Maximum Inlet Pressure	Maximum Flow Rate
PDO605	1/4 BSPT	15 bar / 217 psi	90 l/min / 3.2 cfm
PDO300S	1/2 BSPT	15 bar / 217 psi	450 l/min / 15.9 cfm
PDO600S	3/4 BSPT	15 bar / 217 psi	900 l/min / 31.8 cfm
PDO900S	3/4 BSPT	15 bar / 217 psi	1350 l/min / 47.7 cfm
PDO1500S	1 BSPT	15 bar / 217 psi	2314 l/min / 81.7 cfm
PDO2000S	1 BSPT	15 bar / 217 psi	3085 l/min / 108.9 cfm

DROPOUT® AUTO-DRAIN

The Dropout® Auto-drain is designed to remove all contaminants from the Dropout units automatically. Two 1/2" inlet connections enable flexible installation. It comes supplied with a metal blanking plug to block any unused port.



Features

- Drains all contaminants (liquid water & oil and solid particles)
- No mains power
- Automatic and manual drain options
- Easy to install
- Maintenance free

Part Number	Inlet Connection (in)	Outlet Connection (in)	Water Storage
PDOAD128	1/2 BSPT	1/8 in BSPT	350 cc

PCL AIR TREATMENT

Our FRL range includes combination units with 1/4" and 1/2" inlet ports. Adding a PCL Air Treatment unit into an air line efficiently filters to 10 microns. Products feature polycarbonate bowls, allowing the user to easily monitor the element's condition and the collected liquid's level. The bowl is surrounded with protective metal as a safety measure to protect the user in case of excessive pressures, temperatures, or aggressive chemicals.

Features

- Selectable manual/semi-automatic drain
- Polycarbonate bowl
- Locking device
- 10 micron filter
- Complete with wall bracket and pressure gauge



FILTER-REGULATOR & LUBRICATOR

PCL's FRL Units are designed to control output air pressure, eliminate moisture and contaminants from the air flow, and to lubricate tools during use.



Part Number	Port Size (in)	Adjustment	Maximum Inlet Pressure	Flow @ 6 bar
ATCFRL6	1/4	0-10 bar / 145 psi	12 bar	1,800 l/min
ATCFRL12	1/2	0-12 bar / 170 psi	16 bar	5,000 l/min

FILTER-REGULATOR

PCL's Filter-Regulator units are designed to eliminate moisture and particulates from the air flow.



Part Number	Port Size (in)	Adjustment	Maximum Inlet Pressure	Flow @ 6 bar
ATC6	1/4	0-10 bar / 145 psi	12 bar	1,800 l/min
ATC12	1/2	0-12 bar / 170 psi	16 bar	5,000 l/min

FILTER

PCL's Filters are used to clean and dry compressed air.



Part Number	Port Size (in)	Capacity of drain bowl	Maximum Inlet Pressure	Flow @ 6 bar
ATF6	1/4	30 ml	12 bar	2,100 l/min
ATF12	1/2	50 ml	16 bar	6,000 l/min

LUBRICATOR

PCL's Lubricator is fitted with adjustable lubrication output.



Part Number	Port Size (in)	Cup size	Maximum Inlet Pressure	Flow @ 6 bar
ATL6	1/4	40 ml	12 bar	2,200 l/min
ATL12	1/2	70 ml	16 bar	6,000 l/min

REGULATOR

PCL's Regulators are used to reduce compressed air pressure.



Part Number	Port Size (in)	Adjustment	Maximum Inlet Pressure	Flow @ 6 bar
ATR6	1/4	0-10 bar / 145 psi	12 bar	1,700 l/min
ATR12	1/2	0-12 bar / 170 psi	16 bar	6,000 l/min

PRESSURE GAUGES

These rear entry pressure gauges are calibrated in psi and bar for use with 1/4" and 1/2" Regulator units.



Part Number	Port Size	Calibration
ATG4	R 1/8	0-11 bar / 0-160 psi
ATG8	R 1/4	0-11 bar / 0-160 psi



Couplings & Adaptors

ECONOMY AIR TREATMENT

Hose

ECONOMY AIR TREATMENT

For budget applications, PCL's Economy Air Treatment range of FRLs provides a ready constructed "connect and go" air treatment system which filters to 40 microns and has 1/2" port inlets.

Features

- Semi-automatic drain valve
- Polycarbonate bowls
- 40 micron filter

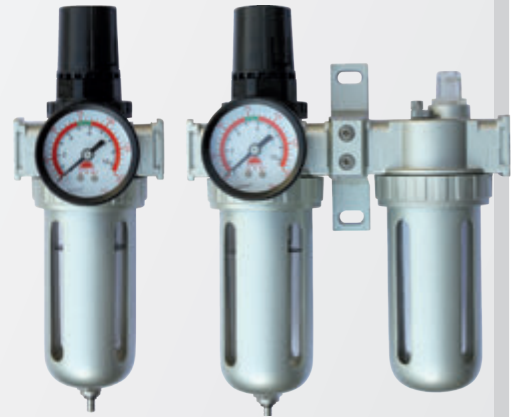

Hose Fittings

Part Number	Description	Port Size (in)	Adjustment	Maximum Inlet Pressure
AFR1	Filter-Regulator	1/2	0-10 bar / 0-150 psi	10 bar
AFRLC1	Filter-Regulator & Lubricator	1/2	0-10 bar / 0-150 psi,	10 bar

Tyre Inflation Equipment

IN-LINE AIR TREATMENT

Tyre Care

IN-LINE FILTER

The In-line Filter is used in addition to existing air treatment in your system and provides any extra filtration for specific applications or tools.

Features

- Temperature range: -10°C to 50°C
- Transparent polycarbonate housing
- 10 micron filter



Part Number	Port Size (in)	Maximum Inlet Pressure	Flow Rate @ 6 bar
INF6	1/4	12 bar	2,100 l/min

IN-LINE LUBRICATOR

The In-line Lubricator is used in addition to existing air treatment in your system and provides any extra filtration required for specific applications or tools.

Features

- Temperature range: -10°C to 50°C
- Transparent polycarbonate housing
- 10ml cup capacity



Part Number	Port Size (in)	Maximum Inlet Pressure	Flow Rate @ 6 bar
INL6	1/4	12 bar	2,700 l/min

Nitrogen Equipment

Workshop Equipment

COMPRESSORS

COMPRESSOR TIPS



- **Avoid using extension leads** with an air compressor, the voltage drop can cause the motor to overheat which will eventually lead to the compressor motor burning out. We recommend using a longer air hose instead.
- If you do plan to run your air tool some distance away from the actual compressor, you must **take into consideration that air flow lost through hoses and fittings will result in pressure drops.** However, the more CFM the compressor produces, the better your tool will run, even with longer hoses and more fittings.

- **Remember to oil your air compressor regularly** so it performs correctly. (You do not need to do this with oil-less compressors).
- **Compressors should be drained frequently** to prevent water from reducing performance. They often fill with water due to moisture content in the air, therefore the compressor has a drain screw located at the lowest part of the receiver to release it.

Air Tools

Air Tool Accessories

COMPRESSORS

WHICH COMPRESSOR IS RIGHT FOR ME?

That depends on what you will be using it for and whether your application is occasional or professional continual use.

You should therefore begin by checking the CFM (Cubic Feet per Minute) to see what flow rate each compressor releases, as this relates to the suitability of the compressor to the type of job.

For example, if it's for a nail gun/impact wrench which will be used for short periods of time a lower CFM would be sufficient; whereas a tool to be used continuously, such as a paint sprayer or sander, would need a higher CFM.

Regardless of the required flow rate, always look for the best rated CFM output with the lowest dB (decibel) output at the lowest HP (Horse Power).

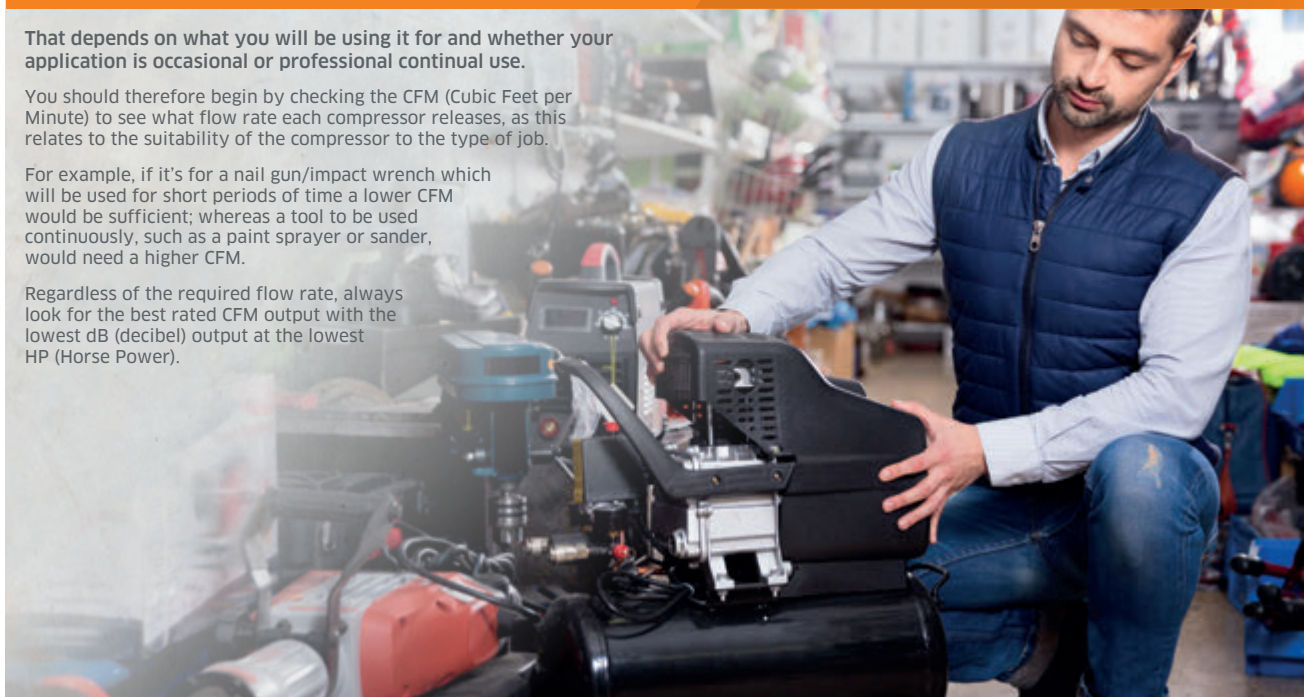

Four factors to consider

Does noise volume matter?

Compressors by nature are noisy. A piston compressor can emit up to 97dB, which could be uncomfortable for long periods of time. If high noise volumes are an issue there are lower rated compressors which typically start with a 60dB output. These are usually called "oil-less" or "silent" compressors.

CFM (FAD/Actually delivered) V CFM (Displacement)

These are the two common terms used to describe the Cubic Feet per Minute of a compressor. CFM (Displacement) relates to what the output from the machine's pump and receiver should be in theory. In practice, once the air begins its journey it will naturally slow down. This is then measured as CFM (FAD). This could be critical to the usage of a tool that is on the cusp of Displacement and FAD.

It is important to establish how much CFM your air compressor needs to produce in order to power all your air tools, so be sure to check the CFM in the catalogue or tool manufacturer's manual. If you plan to run more than one tool at the same time the CFM of each tool should be added together.

This table shows how many seconds a tool will run with various size compressors.

Part No.	Description	Stated CFM	24 l	50 l	100 l	150 l	200 l
APP203T	1/2" TURBO Impact Wrench	4.7	5	11	23	34	45
APP760	PaIm Sander	2.5	10	21	42	64	85
APP405	10mm Air Drill	4.28	6	12	25	37	50
APT740	Tyre Buffer	3	8	18	35	53	71
SG01P	HVLP Suction Spray Gun	6	4	9	18	26	35

For more helpful product advice, visit www.pclairtechnology.com/support

Consider the tank size

This is always a priority focus as smaller tanks are suitable for lighter applications and larger ones are required for heavier/industrial duties. Compressor tanks (receivers) can start as low as 6ltr and go up to 200ltr.

Our handy table below demonstrates how many seconds a tool will run with various size compressors. In general, if you will be using air tools that require continuous air, such as a sander, then you should consider an air compressor with a larger tank. If you're using a tool, for example a drill that operates in short bursts, 6 seconds may be enough, therefore a smaller compressor will suffice.

Belt driven or direct drive compressor

Direct drive compressors are more reliable, powerful, cost-effective and easier to maintain, but if you need to adjust the compressor's speed and power, then a belt driven compressor might be the better option.



Couplings & Adaptors

Hose

Hose Fittings

Tyre Inflation Equipment

Tyre Care

Nitrogen Equipment

Workshop Equipment

Air Tools

Air Tool Accessories



COMPRESSORS

OIL LUBRICATED DIRECT DRIVE COMPRESSORS

PCL's direct drive piston compressors offer great value and are a robust and reliable solution for both trade and DIY workshop applications. Featuring proven and reliable compressor pumps from 2HP to 2.5 HP, direct driven by a high quality electric motor, each model has automatic controls for ease of use and economical operation. Fitted with genuine PCL couplings.

Features

- Fitted with a genuine single stage 2 and 2.5 HP motors
- User friendly clear pressure gauges and oil level gauge
- Fitted with genuine PCL Airflow or XF-Euro couplings on the outlet
- Strong durable wheels
- Twin outlets for greater flexibility
- Simple push on/off button start



Part Number	Air Receiver	Air Flow	Motor	Noise
CM2024D	24 litre	206 l/min / 7.3 cfm,	2 HP / 1.5 kW / 2850 rpm	82 dBA
CM2550D	50 litre	232 l/min / 8.2 cfm	2.5 HP / 1.8 kW / 2850 rpm	89 dBA
Also available with EU plug & XF-Euro couplings				
CM2024D/EU	24 litre	206 l/min / 7.3 cfm,	2 HP / 1.5 kW / 2850 rpm	82 dBA
CM2550D/EU	50 litre	232 l/min / 8.2 cfm	2.5 HP / 1.8 kW / 2850 rpm	89 dBA



BELT DRIVEN COMPRESSORS

Efficient, durable and reliable Belt Driven Compressors, ideal for professional and serious DIY users.

Features

- Aluminium compressor pump and cast cylinder Simple push on/off button start
- Twin capacitors and a centrifugal switch aid trouble free start up on a 13amp supply
- Heavy-duty guards protect belt and flywheel that is diesel pump to aid cooling
- Slow speed, low temperature, low noise
- User friendly clear pressure gauges and oil level gauge

Part Number	Air Receiver	Voltage	Motor	Noise
CM3100B	100 litre	220 v / Single	3 HP / 2.2 kW / 1400 rpm	77 dBA
CM3100B/3	100 litre	400 v / 3 phase	3 HP / 2.2 kW / 1400 rpm	77 dBA
CM3150B	150 litre	220 v / Single	3 HP / 2.2 kW / 1400 rpm	77 dBA
CM3150B/3	150 litre	400 v / 3 phase	3 HP / 2.2 kW / 1400 rpm	77 dBA
CM3200B	200 litre	220 v / Single	3 HP / 2.2 kW / 1400 rpm	77 dBA
CM5200B/3	200 litre	400 v / 3 Phase	5.5 HP / 4 kW / 1400 rpm	77 dBA

COMPRESSOR OIL

PCL's compressor oil (ISO 32) is suitable for rotary screw, vane and reciprocating compressors, including PCL's Direct Drive and Belt Driven models.



Part Number	Description
ISO321L	1 Litre ISO 32 Compressor Oil

Couplings & Adaptors

Hose

Hose Fittings

Tyre Inflation Equipment

Tyre Care

Nitrogen Equipment

Workshop Equipment

Air Tools

Air Tool Accessories

BLOWGUNS

HOW TO SELECT THE RIGHT BLOWGUN

Should I choose plastic or metal?

This is down to personal preference. PCL's latest range of blowguns, ERGO and ERGO EXTREME, is manufactured from highly durable Zytel Nylon, which provides heat and chemical resistance but is lighter in weight than metal products and feels warmer in the hand. Nozzles are usually metal, with internal components made from brass and stainless steel, adding to the increased durability and longevity.

PCL's entry level range is also manufactured from plastic. These blowguns do not have the same high levels of durability, however they do represent excellent value for money.

Where longer life is a priority over comfort, metal blowguns are a good option. PCL offers die-cast alloy products in two styles - pistol or palm - both of which are compact and robust.



For more helpful product advice, visit www.pclairtechnology.com/support

Pressure required

This depends upon the maximum pressure relevant to your Health & Safety air supply and working practices. There is no specific UK legislation relating to this, however OSHA states that industrial safety air blowguns should be used for industrial applications.

Why use safety blowguns?

PCL's safety blowguns feature a cleverly designed safety valve that reduces the output of air to 2 bar and slowly releases air if there is a blockage, reducing the risk of injury. They are designed to ensure noise levels do not exceed 90dB, as continuous, repeated exposure to anything above that poses a significant risk of partial or permanent hearing loss.

Type of nozzle

PCL offers a range of nozzles from the standard conical nozzle to safety nozzles. For industrial applications, conical nozzles should only be used with a blowgun that has a tamper-proof 2 bar valve.

Safety nozzles are available in two types - Aircurtain and Reduced Jet-velocity - and are selected according to the size and shape of the object the air stream is aimed at, as this will dictate whether you need a flat or concentrated pattern of air.

SAFETY NOZZLES



Aircurtain Nozzles
(Flat)



Reduced Jet-velocity Nozzles
(Concentrated)

BLOWGUN SAFETY TIPS



It is a company's duty to ensure the health and safety of its employees, and this includes providing safe equipment that the user is trained to use and aware of associated risks and precautions.

Tips for using air blowguns safely:

- Choose a safety blowgun with a safety valve
- For blowguns without a built-in safety mechanism, reduce pressure to 2 bar or 30 psi gauge pressure
- Always wear eye and ear protection
- Use a blowgun with noise levels below 90dB that meets OSHA standards
- Ensure the end of the blowgun is never blocked
- Never point a blowgun towards yourself or anyone else. Compressed air can enter the bloodstream by getting underneath the skin which can cause an embolism
- Do not use a blowgun as a vacuum or to clean clothing, particularly when clothing is worn



BLOWGUNS

INTRODUCING PCL'S NEW ERGO EXTREME BLOWGUN RANGE

Design-engineered in the UK, with comfort and style in mind, this premium range of blowguns has the PCL DNA running right through it, from handle to tip. This sturdy product, made from durable Zytel Nylon, looks and feels good in the hand, and features a flexible, rubber grip for additional cushioning and increased strength. A newly designed air release valve is built into the body to enable the trigger/air flow to be feathered. Available in 7 options including 2 bar regulated blowguns and safety nozzles.

Features

- Flexible, rubber grip on the handle for additional cushioning and strength
- Re-enforced webbing and robust design for strength and confidence
- Newly designed air release valve built into the body
- Easy storage with multiple hanging points, creating additional space and strength in the handle area
- Rp 1/4 female brass inlet for increased durability



STANDARD ERGO EXTREME BLOWGUNS

Part Number	Air Flow	Sound	Nozzle
BG7501	11.8 cfm / 334 l/min	94 dBa	Standard
BG7502	11.8 cfm / 334 l/min	94 dBa	Extended

Air Inlet: Rp 1/4

Working pressure: 145 psi / 10 bar

ALSO AVAILABLE » PCLK7501 - 13 PIECE BG7501 COUNTERTOP DISPLAY PACK

SAFETY BLOWGUNS & NOZZLES

2 BAR AUTO SAFETY ERGO EXTREME BLOWGUNS



PCL's 2 Bar Auto Safety Blowguns are equipped with an automatic pressure reduction which ensures the air inlet will automatically be reduced to the recommended 2 bar. This virtually eliminates user error, ensuring safety.

Part Number	Air Flow	Sound	Nozzle
BG8501	8.9 cfm / 252 l/min	90 dBa	Standard
BG8502	8.9 cfm / 252 l/min	90 dBa	Extended

TURBO ERGO EXTREME BLOWGUN



PCL's TURBO Nozzle Safety Blowgun is ideal when increased airflow is required, enabling additional air to be absorbed safely through the sides.

Part Number	Air Flow	Sound	Nozzle
BG7508	18.4 cfm / 521 l/min	114 dBa	Turbo

LOW NOISE ERGO EXTREME BLOWGUN



PCL's Low Noise Safety Blowgun is designed to reduce the risk associated with noise exposure. Its innovative nozzle design ensures that the airflow continues through the sides of the pipe if the tip becomes blocked.

Part Number	Air Flow	Sound	Nozzle
BG7506	9.8 cfm / 277 l/min	80 dBa	Low Noise

AIRCURTAIN ERGO EXTREME BLOWGUN



Recommended for use in large areas, PCL's Aircurtain Blowgun with increased air flow meets OSHA requirements for noise and safety. Its flat nozzle ensures air flow is spread out, making the blowgun impossible to block and providing an extremely high blowing force.

Part Number	Air Flow	Sound	Nozzle
BG7505	8.8 cfm / 249 l/min	94 dBa	Aircurtain

Couplings & Adaptors

Hose

Hose Fittings

Tyre Inflation Equipment

Tyre Care

Nitrogen Equipment

Workshop Equipment

Air Tools

Air Tool Accessories

BLOWGUNS

INTRODUCING PCL'S NEW ERGO BLOWGUN RANGE

This sturdy, UK-designed product range is made from durable Zytel Nylon and looks and feels good in the hand. It features a newly designed air release valve, built into the body to enable the trigger/air flow to be feathered and is available in 7 options including 2 bar regulated blowguns and safety nozzles.

Features

- Re-enforced webbing for strength and confidence
- Newly designed air release valve built into the body
- Easy storage with multiple hanging points
- Rp 1/4 female brass inlet for increased durability

STANDARD ERGO BLOWGUNS

Part Number	Air Flow	Sound	Nozzle
BG7001	11.8 cfm / 334 l/min	94 dBa	Standard
BG7002	11.8 cfm / 334 l/min	94 dBa	Extended

Air Inlet: Rp 1/4

Working pressure: 145 psi / 10 bar



ALSO AVAILABLE » PCLK7001 - 13 PIECE BG7001 COUNTERTOP DISPLAY PACK

SAFETY BLOWGUNS & NOZZLES

2 BAR AUTO SAFETY ERGO BLOWGUNS

PCL's 2 Bar Auto Safety Blowguns are equipped with an automatic pressure reduction which ensures the air inlet will automatically be reduced to the recommended 2 bar. This virtually eliminates user error and ensures safety.

Part Number	Air Flow	Sound	Nozzle
BG8001	8.9 cfm / 252 l/min	90 dBa	Standard
BG8002	8.9 cfm / 252 l/min	90 dBa	Extended



LOW NOISE ERGO BLOWGUN

PCL's Low Noise Blowgun is designed to reduce the risk associated with noise exposure. Its innovative nozzle design ensures that the airflow continues through the sides of the pipe if the tip becomes blocked.

Part Number	Air Flow	Sound	Nozzle
BG7006	9.8 cfm / 277 l/min	80 dBa	Low Noise



TURBO ERGO BLOWGUN

PCL's TURBO Blowgun is ideal when increased airflow is required. The nozzle allows the blowgun to absorb air through the sides, increasing airflow and ensuring safety.

Part Number	Air Flow	Sound	Nozzle
BG7008	18.4 cfm / 521 l/min	114 dBa	Turbo



AIRCURTAIN ERGO BLOWGUN

Recommended for use in large areas, PCL's Aircurtain Blowgun with increased air flow is equipped with a flat safety nozzle meeting OSHA requirements on noise and safety. The flat nozzle ensures air flow is spread out, making the blowgun impossible to block and providing an extremely high blowing force.

Part Number	Air Flow	Sound	Nozzle
BG7005	8.8 cfm / 249 l/min	94 dBa	Aircurtain



Couplings & Adaptors

Hose

Hose Fittings

Tyre Inflation Equipment

Tyre Care

Nitrogen Equipment

Workshop Equipment

Air Tools

Air Tool Accessories



BLOWGUNS

Couplings & Adaptors

Hose

Hose Fittings

Tyre Inflation Equipment

Tyre Care

Nitrogen Equipment

Workshop Equipment

Air Tools

Air Tool Accessories

STANDARD SAFETY NOZZLE BLOWGUN

Manufactured from chemical and impact resistant acetal resin, PCL's entry level Rp 1/4 pistol grip Plastic Blowgun is suitable for use with both air and water. It features an innovative safety nozzle design which ensures the airflow cannot be blocked.

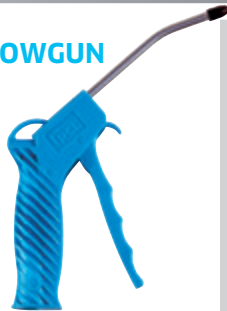

Features

- Ergonomically designed handle, for comfort in use
- Innovative nozzle design ensures that the airflow cannot be blocked
- Valve allows trigger-adjustable airflow
- Brass thread inlet for increased durability
- Maximum supply pressure: 10 bar / 140 psi

Part Number	Air Flow	Nozzle Style
BG5004	270 l/min / 9.3 cfm	Safety

PLASTIC BLOWGUN

Manufactured from chemical and impact resistant acetal resin, this range of entry level Rp 1/4 pistol grip Plastic Blowguns are suitable for use with both air and water.

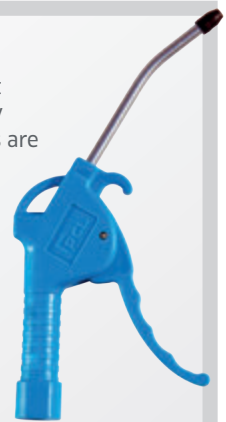

Features

- Ergonomically designed handle, for comfort in use
- Valve allows trigger-adjustable airflow
- 9" extension nozzle can be further cut and bent to suit users application
- Maximum supply pressure: 10 bar / 140 psi

Part Number	Air Flow	Nozzle Style
BG5002	270 l/min / 9.3 cfm	Standard
BG5007	270 l/min / 9.3 cfm	Extended

PISTOL GRIP BLOWGUN

This Rp 1/4 Pistol Grip Blowgun is manufactured from high quality die-cast alloy, giving the tool a long trouble-free life.



Features

- Robust and compact design
- Extensive, easy to fit with additional nozzle range
- Supplied with a conical and safety nozzle
- Maximum supply pressure: 10 bar / 140 psi

Part Number	Air Flow	Nozzle Style
BG405	320 l/min / 11.2 cfm	Conical & Safety

PALM BLOWGUNS

This robust blowgun with Rp 1/4 air inlet is manufactured from high quality die-cast alloy for a long, trouble-free life.



Features

- Robust and compact design
- Extensive, easy to fit with additional nozzle range
- Display packed for convenience
- Maximum supply pressure: 14 bar / 200 psi

Part Number	Air Flow	Nozzle Style
BG105	14.8 l/min / 5.3 cfm	Conical
BG106	14.8 l/min / 5.3 cfm	Safety

AIRVAC

The PCL AirVac is a useful addition to any toolbox. With vacuum and blow functions and numerous attachments, it will keep your workspace clean and free of debris.



Features

- Neat slimline design
- Handy dust bag and extension tube
- Includes 3 different nozzle attachments and 1 extension nozzle

Part Number	Air Consumption
AV301	3.6 cfm / 100 l/min

ECONOMY PALM BLOWGUN

The robust Palm Blowgun with Rp 1/4 air inlet is manufactured from high quality die-cast alloy, giving the tool a long trouble free life.



Features

- Robust and compact design
- Supplied with a conical and safety nozzle
- Display packed for convenience
- Maximum supply pressure: 10 bar / 140 psi

Part Number	Air Flow	Nozzle Style
BG605	240 l/min / 8.9 cfm	Conical & Safety

BLOWGUNS

BLOWGUN NOZZLES

PCL's comprehensive range of threaded (1/8 in inlet), easy to fit nozzles are interchangeable and cater for all blowgun applications.

Part Number	Nozzle Style
BGN4088	Conical
BGN461	Safety
BGN466	9" Extension



SPRAY EQUIPMENT

HVLP SPRAY GUNS

PCL's HVLP Spray Guns are equipped with a precision engineered brass air cap, stainless steel fluid nozzle and needle - providing a premium quality paint finish. This newly developed model is environmentally-friendly, offering high transfer efficiency and lower material consumption.

CHOOSING BETWEEN A SUCTION AND GRAVITY SPRAY GUN

The difference between these two spray guns is the way in which a supply of paint is fed to the nozzle, therefore choosing the style of spray gun is a matter of personal preference.

Gravity spray guns hold the paint container on top of the gun and are generally lighter and easier to clean. They are great for smaller projects and touching up.

Suction spray guns (HVLP) need more compressed air to create the vacuum required to pull paint from the container (situated below) and into the gun - which means a bigger compressor, ideally 50LTR - 100LTR. Their greatest advantage is ease of use, as they can be used at angles a gravity spray gun might struggle with.

WHAT IS HVLP?

HVLP (high-volume, low-pressure) spray guns need a high volume of air (HV) to aerosolize the paint. The combination of high volume and low pressure in the paint container draws the paint upwards. Once it hits the high volume of air, the paint vaporizes and creates a fine spray. This provides greater control of paint application and increased efficiency.

Features

- Reduced overspray minimises wasted paint
- Suitable for water based paints
- Maximum working pressure: 43 psi / 3 bar

Part Number	Air Consumption	Aluminium Cup Capacity	Nozzle Size
HVLP Suction Spray Gun			
SG01P	6 cfm / 170 l/min	1 litre	1.7 mm
HVLP Gravity Spray Gun			
SG02P	5.5 cfm / 156 l/min	0.6 litre	1.4 mm



LITE SPRAY GUNS

This Lite Spray Gun is part of PCL's economy range of products designed for those looking for a fit for purpose product that doesn't cost the earth. Material is lightweight aluminium and the product is supplied with a 1.5 mm nozzle as standard. Suitable for light viscosity painting applications.



Features

- Lightweight materials
- Operating pressure: 3-4 bar / 43-58 psi
- Comes complete with cleaning brush and hosietailpiece adaptor

Part Number	Air Consumption	Aluminium Cup Capacity	Nozzle Size
Suction Spray Gun			
SG01L	4.2-7.1 cfm / 120-201 l/min	0.75 litre	1.5 mm
Gravity Spray Gun			
SG02L	4.2-7.1 cfm / 120-201 l/min	0.61 litre	1.5 mm



SPRAY EQUIPMENT

BODY GUN WITH EXTENSION PROBE

PCL's user-friendly Body Guns are suitable for both water-based and oil-based fluids. Designed for easy operation, the fluid flow is adjustable and easily regulated with the trigger, whilst the ergonomic handle never cools during use.

Features

- User friendly design
- Guaranteed long service life
- Robust and impact resistant material
- Guaranteed leak-free valve system, even after millions of operations



ALSO AVAILABLE » BDY146110 - 900 MM EXTENSION PROBE

Part Number	Air Consumption @ 8 bar with nozzle	Air Consumption @ 8 bar with hose
BDY146105	13.4 cfm / 380 l/min	6.4 cfm / 150 l/min

Maximum supply pressure: 16 bar / 232 psi

UNDERSEAL GUN

PCL Underseal Guns work well for the treatment and maintenance of cars and other vehicles that are subject to corrosion and stone chipping. Designed to fit 1 litre disposable/fillable containers, these guns are suitable for both water-based and oil-based fluids.

Features

- User friendly design
- Guaranteed long service life
- Robust and impact resistant material
- Guaranteed leak-free valve system, even after millions of operations



Part Number	Air Consumption @ 8 bar with nozzle
BDY146134	13.4 cfm / 380 l/min

Maximum supply pressure: 16 bar / 232 psi

WATER DISPENSER

A sturdy solution to dispensing water, for example in radiators or windscreen bottle fillers. PCL's Water Dispenser has a non-slip rubber-covered body, with valve and lever for instant flow and cut-off.

Features

- Sturdy design
- Lever gives instant flow and cut-off



Part Number	Maximum Working Pressure	Air Inlet
RF104	30 bar / 435 psi	Rp 3/8

SANDBLASTING GUN

PCL's powerful Sandblasting Gun is a handy tool to have at hand when you need to remove rust and ingrained dirt from surfaces. This efficient and lightweight tool is easy to operate with practical refillable 1.2 litre containers. We recommend sand grade 00 with grain size 0.3-0.6mm for standard tasks, and for coarser work, sand grade 0 with grain size 0.4-0.8mm.

Features

- User friendly design
- Guaranteed long service life
- Robust and impact resistant material
- Guaranteed leak-free valve system, even after millions of operations



Part Number	Air Consumption @ 8 bar with nozzle
SBG145100	15.9 cfm / 450 l/min

Maximum supply pressure: 12 bar / 174 psi

CLEANING (PARAFFIN) GUN

PCL's powerful and efficient cleaning gun is suitable for most kinds of cleaning agents, making it a dynamo for degreasing, cleaning and detergent coating, even where aggressive chemicals are used.

Features

- User friendly design
- Guaranteed long service life
- Robust and impact resistant material
- Guaranteed leak-free valve system, even after millions of operations



Part Number	Air Consumption @ 8 bar with nozzle	Container	Nozzle Length
PSG142130	3.5 cfm / 100 l/min	1.2 litre	150 mm

Maximum supply pressure: 12 bar / 174 psi

Couplings & Adaptors

Hose

Hose Fittings

Tyre Inflation Equipment

Tyre Care

Nitrogen Equipment

Workshop Equipment

Air Tools

Air Tool Accessories

BRAKE BLEEDERS

BRAKE BLEEDERS

PCL's Brake Bleeders make light work of bleeding and refilling the brake systems of all types of vehicles. User-friendly and efficient, they enable a single person to get the job done quickly and cleanly. Available with a replenishment system for cars or motorcycles.

Features

- Simple, single person operation
- Does not require specialised brake reservoir caps
- Quick, clean and efficient
- Draws fluid from the bleed nipple enabling either bleeding or full replacement of fluid in system
- Maximum working pressure: 6-12 bar / 87-174 psi



Part Number	Supplied with	Air Consumption @ 8 bar
BB143102	-	6.4 cfm / 180 l/min
BB143112	Replenishment system	6.4 cfm / 180 l/min

OIL EXTRACTOR

OIL EXTRACTOR

PCL's reliable and easy to operate Oil Extractor is highly resistant to corrosion, and suitable for changing a variety of oils - including hydraulic, cutting and engine oil - on tractors, cars, boats, motorcycles, garden machinery and other types of engines.

Features

- Simple, single person operation
- Oil flow is infinitely adjustable and easily regulated by the trigger
- Quick, clean and efficient
- Ideal for changing oil on tractors / cars / boats
- Maximum working pressure: 12 bar / 174 psi



Part Number	Air Consumption @ 8 bar with nozzle	Air Inlet
OE147160	6.4 cfm / 180 l/min	Rp 1/4

HOSE REELS

RETRACTA SPRING REWIND HOSE REELS

The original Retractable polypropylene reel has built an enviable reputation for reliability in the toughest environments across the globe.

The patented, world-first RACR 'Retractable Adjustable Control Return' system can be retro fitted to any R3 Retractable and enables the user full control to set the speed of return to suit individual requirements.

Features

- High visibility yellow hose for extra safety
- Optimised safety with RACR® adjustable rewind speeds
- Overrun protection on spring preventing spring damage on drum
- Increased internal capacity reduces hose build-up and allows longer hose lengths
- Safe tensioning mechanism with uni-directional ratchet stops main spring release while tensioning
- Steel wall-mounting 180o swivel bracket

Part Number	Hose Length	Hose I.D.	Inlet Size	Hose Type
HRA3V02	20 m	10 mm / 3/8"	3/8"	Yellow PVC blend
HRA3V03	15 m	12.5 mm / 1/2"	1/2"	Yellow PVC blend



Working pressure: 250 psi / 17 bar

Part Number	Description
HRA3SR	Retractable Adjustable Control Return

Couplings & Adaptors

Hose

Hose Fittings

Tyre Inflation Equipment

Tyre Care

Nitrogen Equipment

Workshop Equipment

Air Tools

Air Tool Accessories



HOSE REELS

Couplings & Adaptors

Hose

Hose Fittings

Tyre Inflation Equipment

Tyre Care

Nitrogen Equipment

Workshop Equipment

Air Tools

Air Tool Accessories

INTRODUCING PCL'S NEW HOSE REEL RANGE

3 sizes to suit user needs

Specifically designed for use with compressed air in garages, workshops and industrial applications, PCL's hose reel range comes in three sizes, with different hose lengths and diameters to suit user needs.

Each features a hose stop that stops in any position and is adjustable at the flick of a lever. All except the two bench top hose reels are slow retract, taking up to 9 seconds.

Easy to maintain, cleaning brushes are now included as standard to avoid debris being taken back into the reel, which can cause the layering system to fail.

Features

- Easy to use adjustable hose stopper - Reduces non-value-added time
- High impact polypropylene construction for maximum durability
- Auto retract - Easily and smoothly rewinds the hose
- Copper tail coupling with dust cap
- Supplied with cleaning brushes
- Steel wall mounting 180° swivel bracket

Hose: PVC or Rubber/PVC Blend
Case type: Polypropylene

BENCH TOP HOSE REELS

The compact and hard-wearing Bench Top Hose Reel is perfect for confined environments where space is a major factor and robustness and reliability is essential. The new reels have a 1/4" BSPT connection and a working pressure up to 120 psi / 8 bar.



Part Number	Hose Length	Hose I.D.	Inlet & Outlet Size	Hose Type
HRA2W	10 m	6 mm	1/4" BSPT	PVC
HRA2X	8 m	8 mm	1/4" BSPT	PVC

Working pressure: 120 psi / 8 bar



WORKSHOP PRO HOSE REELS

Designed with safety in mind, PCL's medium-sized Workshop Pro Hose Reels with 1/4" BSPT connection feature a slow retracting mechanism that prevents accidental loss of hose control during retraction, reducing the risk of injury or damage.



Part Number	Hose Length	Hose I.D.	Inlet & Outlet Size	Hose Type
HRA3K01	10 m	8 mm	1/4" BSPT	PVC
HRA3L02	15 m	10 mm	1/4" BSPT	PVC
HRA3L03	20 m	10 mm	1/4" BSPT	Rubber / PVC Blend

Working pressure: 250 psi / 17 bar
HRA3K01 Working pressure: 120 psi / 8 bar

WORKSHOP PRESTIGE HOSE REELS

PCL's Workshop Prestige Hose Reels are the largest reels of the new range with a 1/2" BSPT connection. The reels feature a slow retracting mechanism which prevents accidental loss of hose control during retraction, reducing the risk of injury or damage.

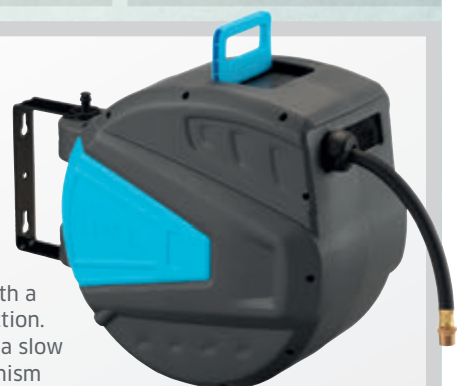

Part Number	Hose Length	Hose I.D.	Inlet & Outlet Size	Hose Type
HRA3M01	15 m	12 mm	1/2" BSPT	PVC
HRA3M02	18 m	12 mm	1/2" BSPT	Rubber / PVC Blend

Working pressure: 250 psi / 17 bar

TECALEMIT



The TECALEMIT brand is well-known on the global market as a pioneer in lubrication solutions and fuel dispensing technology, mainly for diesel fuel, oil, grease, lubricants and AdBlue®.

With over a 100 years' experience of manufacturing premium, cost-effective equipment that is rugged, reliable and easy to use, TECALEMIT is proud of its "Made in Germany" heritage.

The TECALEMIT portfolio includes pumps, fluid handling and dispensing products, along with other associated workshop equipment.

HAND PUMP K 10 C

The hand-operated K 10 C is an ATEX-approved piston pump for the transfer of fuels and oils from a drum or small container. The M64 x 4 and G2" threads are integrated in the housing for simple assembly. Available with two different suction pipes, it is suitable for use with diesel, RME, petroleum (hazard class A1-III), Kerosene (hazard class A1-II), gas oil, low viscosity mineral oils and antifreeze (concentrate).



CONFORMS TO » ATEX MARK EX II 2/2 G C IIA T3

Part Number	Suction Pipe Type	Hose
103 083 000	Rigid	Not included
103 089 000	Telescopic	Not included
103 089 100	Telescopic	1.5 m hose with anti-kink spring
103 089 200	Telescopic	1.5 m hose with grounding wire

- Capacity: 0.25 l/stroke
- Rigid suction pipe length: 840 mm
- Telescopic Suction Pipe Length: 470 - 925 mm
- Drum thread: M 64 x 4 / G 2"

Features

- For drums and small containers
- Single-action piston pump with siphonic action
- 1.5 m conductive fuel delivery hose with anti-kink spring

HAND PUMP OK 9 B

Built for long term durability, this hand-operated crank pump is used to distribute oil out of drums and small containers and is suitable for motor, gear and hydraulic oil up to SAE 80. The OK 9 B is a single-action piston pump with siphonic action, and comes complete with a 470-925 mm telescopic suction pipe.

Features

- For drums and small containers
- Single-action piston pump with siphonic action
- Non-drip outlet
- Adjustable drum screw connector

Part Number	Suction Pipe Type	Outlet
122 023 000	Rigid	Non-drip spout
122 029 000	Telescopic	Non-drip spout
122 029 100	Telescopic	1.5 m dispensing hose

- Capacity: 0.25 l/stroke
- Suction pipe length: 490 - 925 mm
- Drum thread: G 2"



Couplings & Adaptors

Hose

Hose Fittings

Tyre Inflation Equipment

Tyre Care

Nitrogen Equipment

Workshop Equipment

Air Tools

Air Tool Accessories



TECALEMIT

Couplings & Adaptors

Hose

Hose Fittings

Tyre Inflation Equipment

Tyre Care

Nitrogen Equipment

Workshop Equipment

Air Tools

Air Tool Accessories

HAND ROTARY PUMP KP 01

TECALEMIT'S hand-operated rotary KP 01 Hand Pump is for the distribution of oil out of drums and small containers. Suitable for diesel, gas oil, low viscosity mineral oils SAE 50, engine oil, gearbox oil (up to SAE 140) and hydraulic oil.

Features

- Rigid suction pipe
- Rugged and hard-wearing
- Working principle rotation, making it easier to turn rapidly



Part Number	Description
-------------	-------------

131 130 100	KP 01 Hand Pump
--------------------	-----------------

- Capacity: 0.25 l/stroke
- Suction pipe length: 990 mm
- Drum thread: G 2"

HAND CRANK PUMP HK 07

TECALEMIT's hand-operated, single-action piston crank pump distributes engine, gear and hydraulic oil out of drums and small containers. The HK 07 has a telescopic suction pipe which extends up to 850 mm.

Features

- Single-action piston pump
- Telescopic suction pipe extends up to 890 mm
- Suitable for low viscosity minerals oils up to SAE 50



Part Number	Description
-------------	-------------

129 501 700	HK 07 Hand Pump
--------------------	-----------------

- Flow rate: 0.35 l/stroke
- Suction pipe length: 890 mm
- Drum thread: G 1 1/2 & G 2"

PCP 250 HAND PUMP FOR CHEMICALS

TECALEMIT's hand-operated piston pump is designed for the distribution of chemicals out of drums and small containers.

Features

- Single-action
- Includes 1.2m hose set



Part Number	Description
-------------	-------------

131 053 200	PCP 250 Hand Pump for Chemicals
--------------------	---------------------------------

- Flow rate: 0.25 l/stroke
- Suction pipe length: 840 mm
- Drum thread: G 2"

HAND PUMP FOR ADBLUE®

TECALEMIT's hand lever pump has been designed for the simple, cost-effective transfer of AdBlue®, also known as DEF, from a 200 litre drum.

Incorporating a plastic housing with outlet tap, it comes complete with a 1.5m pressure hose.

Features

- Hand lever pump in plastic housing with outlet tap
- Three-parts, telescopic suction pipe 640 - 980 mm
- For use with 200 litre drums
- Pressure hose 1.5 m with outlet manifold
- Includes adaptor for S56 x 4 and S70 x 6 buttress thread



Part Number	Description
-------------	-------------

131 053 000	Hand Pump For AdBlue®
--------------------	-----------------------

- Flow rate: 0.5 l/stroke
- Suction pipe length: 690 - 980 mm
- Drum thread: 2" BSP

TECALEMIT

HIGH-PRESSURE TWO HANDED LEVER-TYPE GREASE GUN

This two-headed industrial, grease gun is stable, robust, reliable and easy to operate. It features a 4 jaw hydraulic connector for lubrication procedures conducted on high-quality machines with long lubrication lines. The light-weight design with ergonomic handles and nozzle holder, ensures precision and cleanliness.

Features

- Extreme ease of operation and reliable lubrication
- 300 mm high pressure hose
- 4 jaw hydraulic connector
- Holds 500 g screw-on cartridges

Part Number	Description
011 681 051	High Pressure Two-handed Lever Type Grease Gun

- Pressure capacity: Max. 400 bar
- Delivery rate / stroke: up to 2 cm³
- Connection thread: M 10 x 1 IG



LEVER-OPERATED GREASE GUNS

These compact and robust industrial grease guns feature a lever handle mechanism and vinyl cover, providing a comfortable grip, whilst an extension pipe helps the user to reach tight areas. Available with a 150mm nozzle tube or 300mm high pressure hose, guns come with a 4-jaw hydraulic connector.

Features

- Lever handle grip
- 4 jaw hydraulic connector
- Holds 400 g cartridge / 500 cm³ content

- Pressure capacity: Max. 400 bar
- Delivery rate / stroke: up to 2 cm³
- Connection thread: M 10 x 1 IG

Part Number	Description	Nozzle Tube
011 681 021	Lever-type Grease Gun	150 mm
011 681 031	Lever-type Grease Gun	300 mm
011 681 041	One-handed Lever-type Grease Gun	150 mm



011 681 041

011 681 031

011 681 021

TANKQUICK ECO

The Tankquick Eco is a fuel suction unit with changeable container and level indicator suitable for a wide range of applications, including extracting fuel from vehicle tanks in workshops, the drainage of vehicles in car dealerships and removing fuel at petrol forecourts where the incorrect fuel has been used.

ATEX approved, complying with vigorous safety requirements for explosive areas, Tankquick Eco is fitted with a pneumatic extraction and refilling unit with practical single hose and vapor recovery system.



Features

- Electrically conductive hose and transport system
- Potential equalization
- Vapor recovery system
- Overfill indicator
- 4 casters with parking brake

Part Number	Effective Capacity	Suction Hose	Delivery Rate
013 896 200	110 litre	15 x 9 mm	7.5 l/min



Couplings & Adaptors

Hose

Hose Fittings

Tyre Inflation Equipment

Tyre Care

Nitrogen Equipment

Workshop Equipment

Air Tools

Air Tool Accessories

TECALEMIT

FMT 3 FLOW METER

BEST SELLER

Use with
all flow
directions

TECALEMIT's new generation FMT electronic flow meter is impressively robust and versatile in its suitability for a wide range of liquids.

Compact and easy to use, it measures passing liquid using the principle of a turbine wheel counter. This means minimal disruption to the flow, which can continue right through the turbine, resulting in little pressure loss whilst allowing the speed to remain high. The two-line LED display then shows the current dispensation values and total stored volume or 8 partial stored volumes.

A symmetric measurement chamber allows the device to be used with all flow directions, therefore only one flow meter is necessary.

Features

- Display can be rotated in 90° increments
- Precise measurements – less than ±1%
- Large, illuminated display
- Long battery life - approx. 5 years
- For use with a wide range of liquids such as fuel oil/ diesel, water, AdBlue®, and antifreeze



Part Number	Flow Rate	Nominal Pressure	External Thread
253 591 006	5-120 l/min	10 bar / 145 psi	1 in

Explore our wide range of hoses

To complement PCL's vast range of couplings, adaptors and tyre inflation equipment, a wide variety of air hoses are available. PCL's air hoses come in convenient cut lengths between 10m and 100m.

For your convenience PCL also has a range of hose assemblies, complete with couplings and adaptors – just plug in and go.

See pages 22-29



Couplings & Adaptors

Hose

Hose Fittings

Tyre Inflation Equipment

Tyre Care

Nitrogen Equipment

Workshop Equipment

Air Tools

Air Tool Accessories

AIR TOOLS



PCL's extensive range of air tools is designed to meet the rigorous needs of a busy, modern workshop, comprising everything from impact wrenches and ratchets, to sanders and grinding tools. It includes the PRESTIGE set of high-quality tools, which provide low vibration, low noise, ergonomic grip and higher performance.

BEST SELLER



PRESTIGE Turbo 1/2" Impact Wrench

Page 92



PRESTIGE Stubby 1/2" Impact Wrench

Page 93



PRESTIGE Compact 1/2" Impact Wrench

Page 93



PRESTIGE Battery Operated 1/2" Impact Wrench

Page 93



PRO 1/2" Impact Wrench

Page 94



PRO 1/2" Impact Wrench

Page 94



PRO 1/2" Impact Wrench

Page 95



PRESTIGE Compact 3/8" Impact Wrench

Page 95



PRO 3/8" Impact Wrench

Page 95



PRESTIGE 3/4" Impact Wrench

Page 95

AIR TOOLS



Couplings & Adaptors					
Hose	PRESTIGE 1" Impact Wrench	PRO 1" Heavy Duty Impact Wrench	PRO 1" Pistol style Impact Wrench	PRO High Torque 1" Heavy Duty Impact Wrench	BEST SELLER PRESTIGE 3/8" & 1/2" Ratchets
Hose Fittings	Page 96	Page 96	Page 96	Page 96	Page 97
Tyre Inflation Equipment					
Tyre Care	PRO 3/8" & 1/2" Ratchets	PRESTIGE 3/8" Lumhammer Ratchet	PRESTIGE Die Grinder Set	PRO 4" & 7" Angle Grinders	PRO 6mm Die Grinder
Nitrogen Equipment	Page 97	Page 97	Page 98	Page 98	Page 98
Workshop Equipment					
Air Tools	PRO Tyre Buffer	PRESTIGE Palm Sander	PRO 6" Orbital Sander	PRO 10mm Belt Tension Sander	PRO 20mm Belt Tension Sander
Air Tool Accessories	Page 98	Page 99	Page 99	Page 99	Page 99
			NEW 		
	PRESTIGE 10mm Air Drill	PRO 10mm Reversible Air Drill	PRO 10mm Reversible Air Drill	PRO 10mm Angled Air Drill	PRESTIGE 1/4" HEX Air Screwdriver
	Page 100	Page 100	Page 100	Page 100	Page 101
	PRO 1/4" Hex Pistol Screwdriver	PRO 1/4" Hex Straight Screwdriver	PRESTIGE Air Body Saw	PRO Body saw	PRESTIGE 3" Cut Off Tool
	Page 101	Page 101	Page 101	Page 101	Page 102



PRO 3" Cut Off Tool

Page 102



PRO Metal Shear

Page 102



PRO Air Nibbler

Page 102



PRO Air Hammer

Page 103



PRO Riveter

Page 103



PRO Needle Scaler

Page 103



PRO Nail & Staple Gun

Page 102



PRESTIGE De-Scaling set

Page 103



Mini Air Ratchets

Page 104



Mini 6mm Straight Die Grinder

Page 104



Mini 6mm Angle Die Grinder

Page 104



Mini 2" Angle Die Grinder

Page 105



Mini 2" & 3" Sanders

Page 105



Mini 1/4" Straight Drill

Page 106



Mini 1/4" Angle Drill

Page 106



Mini 3" Angle Cutter

Page 106



Grease Gun

Page 107



310ml Cartridge Caulk Gun Dispenser

Page 107



Compressed air sealing gun

Page 107



Telescopic Multi-function Cartridge Gun

Page 107

Couplings & Adaptors

Hose

Hose Fittings

Tyre Inflation Equipment

Tyre Care

Nitrogen Equipment

Workshop Equipment

Air Tools

Air Tool Accessories

IMPACT WRENCHES

PRESTIGE TURBO 1/2" IMPACT WRENCH

BEST SELLER

The 1/2" Turbo Impact Wrench is the flagship product of PCL's PRESTIGE range. Fast, strong and exceptionally robust, its professional, stylish design features an ergonomic, warm grip handle for extra comfort, whilst the even balance ensures it can be used safely by both apprentices and experienced engineers.

Features

- Durable body casing for maximum use
- Balance weight distribution easing fatigue during continuous use
- Strong, fast & low vibration
- Comfortable rubber handle, protects against the chill of compressed air



PRESTIGE air tool

Part Number	Size	Torque	Weight	Vibration
APP203T	1/2"	1,058 Nm	1.94 kg	6.48 m/s

APPLICATION » TYRE SHOPS, GARAGES

DOES MY POWER TOOL NEED TO BE PNEUMATIC?

Deciding whether or not a pneumatic tool is the right choice for you will ultimately depend on the following:

Do you need a high performance tool?

Air tools use simple air motors or pistons rather than an electric motor, making them considerably lighter than electric tools, with a high power to weight ratio. Therefore, if high performance and all-day use are key factors, air tools deliver the best results and reduce user fatigue.

What is your working environment like?

Air tools are quite slim compared to electric tools, which have bulky motors. This makes them ideal for areas where space is limited, or in cramped locations, for example when working on cars.

Air tools are also easy to switch over on the air line, with no need to keep plugging them into an AC socket or down tools when an extension lead won't reach. This enables the user to get jobs done more quickly and conveniently.

Do you have easy access to compressed air?

If you don't already have an air line there will be the initial expense of setting one up to use air tools. However, pneumatic tools provide lower on-going maintenance costs than electric tools as they have fewer working parts that can go wrong. This can result in long-term savings.



Couplings & Adaptors

Hose

Hose Fittings

Tyre Inflation Equipment

Tyre Care

Nitrogen Equipment

Workshop Equipment

Air Tools

Air Tool Accessories



PCL'S AIR TOOL COLLECTIONS

PRESTIGE air tools

PCL's PRESTIGE range provides the ultimate in performance for the serious professional user, offering:

- Proven technology aimed at getting the job done faster and more easily
- Reduced noise and vibration output compared to other tools on the market
- Ergonomic grip designed to reduce fatigue during prolonged periods of usage
- Lightweight bodies ideal for frequent use

PRO air tools

PCL's PRO range is aimed at the everyday tradesman who requires a price competitive air tool without the worry of compromising on quality or performance.

Specifically designed to withstand the rigours of day to day use in the heaviest of workshop and tyre environments, PCL's PRO range delivers without exception.

PCL MINI air tools

The PCL MINI range delivers the same outstanding performance and quality in a compact size, offering:

- Compact and lightweight design for maximum operator control
- Ultimate flexibility, allowing access to small areas which are often unreachable with conventional air tools, even managing difficult to operate standard hand tools
- Soft grip for superior comfort and non-slip feel
- High power motor for consistent performance

PRESTIGE COMPACT 1/2" IMPACT WRENCH

Professional and compact, the PRESTIGE 1/2" Impact Wrench packs a mighty punch, allowing access to difficult to reach areas. Ergonomic and lightweight in design, this unit is comfortable to use, whilst its durable body provides longevity of life.

Features

- Durable body casing for maximum use
- Comfortable rubber handle, protects against the chill of compressed air
- Lightweight, enables continuous use
- Ergonomic design reduces fatigue and vibration impact



PRESTIGE air tool

APPLICATION » TYRE SHOPS, GARAGES, MANUFACTURING

Part Number	Size	Torque	Weight	Vibration
APP201	1/2"	433 Nm	1.29 kg	2.53 m/s

IMPACT WRENCHES

PRESTIGE STUBBY 1/2" IMPACT WRENCH

As the lightest and most compact wrench available, the Stubby 1/2" Impact Wrench performs in areas others cannot reach. Its design enables users to work on jobs in difficult to access areas, from brake disc and front end work to removing wheels.

Features

- Durable body casing for maximum use
- Hanging hook for easy storage
- One handed forward / reverse action
- Compact design for difficult to reach areas



PRESTIGE air tool

APPLICATION » GARAGES, MANUFACTURING, WORKSHOPS

Part Number	Size	Torque	Weight	Vibration
APP200	1/2"	678 Nm	1.3 kg	2.53 m/s

PRESTIGE BATTERY OPERATED 1/2" IMPACT WRENCH

The robust and handy Battery Operated 1/2" Impact Wrench is a fantastic addition to any workshop toolbox, offering an impressive 550 Nm torque. Its reliable li-ion management battery system enables operators to use the wrench in all areas of the workplace, providing peace of mind and convenience. Charging time is just 1 hour, and a fully charged battery can loosen an impressive 150 wheel nuts.

PRESTIGE air tool

Features

- 1hr Charging time
- Supplied with 1x 18V (3.0 Ah) battery
- Loosen / tighten 150 wheel nuts
- Visible charging indicator
- Convenient carry case with charger



APPLICATION » GARAGES, WORKSHOPS

Part Number	Size	Torque	Weight	Vibration
APC218/2B	1/2"	550 Nm	3.2 kg	12.83 m/s

Couplings & Adaptors

Hose

Hose Fittings

Tyre Inflation Equipment

Tyre Care

Nitrogen Equipment

Workshop Equipment

Air Tools

Air Tool Accessories



Couplings & Adaptors

IMPACT WRENCHES

Hose

PRO 1/2" IMPACT WRENCH

Ideal for general purpose repairs in busy workshops, the PRO 1/2" Impact Wrench is designed and manufactured to PCL's high standards, featuring a pin clutch hammer mechanism with forward and reverse mode.



Hose Fittings

Tyre Inflation Equipment

APPLICATION » WORKSHOPS, GARAGES

PRO air tool

Features

- Forward and reverse mode
- Non slip comfortable grip
- Maximum torque 540 Nm
- Good weight distribution for maximum comfort



Part Number	Size	Torque	Weight	Vibration
APT205	1/2"	540 Nm	2.4 kg	1.39 m/s

Tyre Care

Nitrogen Equipment

PRO 1/2" IMPACT WRENCH

The twin hammer PRO 1/2" Impact Wrench features a traditional design with increased power and smoother balanced action. Its aluminium body provides ample protection for the rigours of the workplace. Delivering 594 Nm torque, this Impact Wrench is ideal for tyre changing and front end work.



APPLICATION » WORKSHOPS, GARAGES, TYRE SHOPS

PRO air tool

Features

- Twin hammer mechanism
- Excellent balance
- 4 forward impact settings
- Comfortable to use
- Progressive throttle



Part Number	Size	Torque	Weight	Vibration
APT208	1/2"	594 Nm	2.6 kg	2.44m/s

Workshop Equipment

FOUR STEPS TO PEAK AIR TOOL PERFORMANCE

1. **Check the volume of compressed air required** by the tool to work properly and efficiently. This value is given in cubic feet per meter (cfm) or in litres per second/minute (l/s or l/m).
2. **Check the recommended hose diameter** as this affects working pressure. The correct measurement will ensure your tools perform at their best.
3. **Check the air tool inlet size** to help you choose the correct size connector.
4. **Check the inlet type** as there are three types of inlet threads which should never be mixed:
 - BSP (British standard pipe): commonly used in Europe
 - NPT (National pipe thread): Commonly used in USA
 - PT (Pipe thread): commonly used in Asia



Air Tools

Air Tool Accessories



IMPACT WRENCHES

PRO 1/2" IMPACT WRENCH

The PRO 1/2" Impact Wrench combines power with a lighter weight composite body and ergonomic handle for prolonged use without fatigue. Delivering 800 Nm of torque, this PRO wrench makes easy work of any task.



PRO air tool

APPLICATION » WORKSHOPS, GARAGES, TYRE SHOPS

Features

- Twin hammer mechanism
- Forward and reverse mode
- 4 Forward impact settings
- Progressive throttle
- Excellent power to weight ratio

Part Number	Size	Torque	Weight	Vibration
APT233	1/2"	800 Nm	1.95 kg	4.21 m/s

PRO 3/8" IMPACT WRENCH

The PRO general purpose 3/8" Impact Wrench is ideal for bench work, small engine and body repairs, ignitions, body panels and transmissions.

Features

- Single hammer mechanism
- Forward and reverse mode
- Rear exhaust



PRO air tool

APPLICATION » WORKSHOPS

Part Number	Size	Torque	Weight	Vibration
APT105	3/8"	102 Nm	1.25 kg	3.4 m/s

PRESTIGE COMPACT 3/8" IMPACT WRENCH

Powerful and compact, this PRESTIGE 3/8" impact wrench is a small but mighty tool, allowing easier access to difficult areas. Ergonomic in design, it is comfortable to use, whilst its lightweight yet durable body provides longevity of life.



PRESTIGE air tool

APPLICATION » TYRE SHOPS, GARAGES, MANUFACTURING

Features

- Twin hammer mechanism
- Durable body casing for maximum use
- Comfortable rubber handle, protects against the chill of compressed air.
- Lightweight, enables continuous use
- Ergonomic design reduces fatigue and vibration impact

Part Number	Size	Torque	Weight	Vibration
APP101	3/8"	271 Nm	1.28 kg	3.09 m/s

PRESTIGE 3/4" IMPACT WRENCH

With its high performance motor delivering 1,620 Nm torque, combined with low vibration and smooth balanced blows, the PRESTIGE Impact Wrench makes light work of changing larger tyres. Meanwhile the uphill soft grip makes it comfortable to hold, even for long periods of operation, making it ideal for use in spring work maintenance of buses, trucks, farm machinery, truck tyre work and major engine tear down.



APPLICATION » TRUCK GARAGES, FARM VEHICLE GARAGES, BUS DEPOT'S

PRESTIGE air tool

Features

- Ergonomic design for comfort
- Lightweight
- Reduced vibration

Part Number	Size	Torque	Weight	Vibration
APP234	3/4"	1,620 Nm	3.23 kg	9.18 m/s

Couplings & Adaptors

Hose

Hose Fittings

Tyre Inflation Equipment

Tyre Care

Nitrogen Equipment

Workshop Equipment

Air Tools

Air Tool Accessories



Couplings & Adaptors

Hose

Hose Fittings

Tyre Inflation Equipment

Tyre Care

Nitrogen Equipment

Workshop Equipment

Air Tools

Air Tool Accessories

IMPACT WRENCHES



PRESTIGE 1" IMPACT WRENCH

The PRESTIGE 1" Impact Wrench has excellent power to weight ratio which makes it one of the most popular 1" impact wrenches available. This robust unit handles the rigours of heavy tyre changing workshops with ease.

Features

- Twin hammer mechanism
- Single mounted handle for control and accuracy
- Swivel air inlet prevents hose kinking

APPLICATION » BUS DEPOTS, PLANT HIRE

PRESTIGE air tool



Part Number	Size	Torque	Weight	Vibration
APP271	1"	2,712 Nm	7.9 kg	12.57 m/s

PRO 1" HEAVY DUTY IMPACT WRENCH

With its extended 200mm shank ensuring power reaches the desired target, this powerful 1" unit is designed for use on heavy machinery, trucks and other commercial vehicles. The side handle provides comfort and helps balance the machine whilst in use.

Features

- 200 mm extended shank
- 3 forward operating impact settings
- Robust heavy duty design
- Easy 1 knob power shift
- Twin hammer mechanism



PRO air tool

APPLICATION » RESCUE SERVICES, BUS WORKSHOPS, COMMERCIAL VEHICLE CENTRES

Part Number	Size	Torque	Weight	Vibration
APT263	1"	2,440 Nm	11.5 kg	8.4 m/s

PRO 1" PISTOL STYLE IMPACT WRENCH

This traditional pistol style wrench delivers 2,170 Nm of high torque for heavy machinery, trucks, buses, farm machinery and other heavy industrial applications. The side handle provides a comfortable ergonomic grip for increased control.

Features

- Durable
- Twin hammer mechanism
- Side handle ensures excellent balance
- Compact and powerful
- Ergonomic handle for comfortable use



PRO air tool

Part Number	Size	Torque	Weight	Vibration
APT265	1"	2,170 Nm	8.93 kg	17.7 m/s

PRO HIGH TORQUE 1" HEAVY DUTY IMPACT WRENCH

With a massive 3,390 Nm of torque and a 200mm extended shank, the powerful PRO Impact Wrench gets the power to exactly where it needs to be. Fantastic for heavy industrial work, it makes light use of maintenance work on buses, trucks and other commercial vehicles.

Features

- Suitable for heavy machinery and vehicle maintenance
- Side handle for balance and positive motion to the nut
- Robust, cast aluminium structure ensures longevity in harsh environments



Part Number	Size	Torque	Weight	Vibration
APT266	1"	3,390 N/m	13 kg	11.16 m/s



RATCHETS

PRESTIGE 3/8" & 1/2" RATCHETS

BEST SELLER



Easy speed control and fast run down speed are two factors that make the lightweight yet robust PRESTIGE ratchet a must for the workshop toolbox. These features give the engineer greater control and comfort in engine compartment extremes.

PRESTIGE air tool

Features

- Lightweight
- Reduced vibration
- Fast run down speed
- Easy speed control

Part Number Size

APP310 3/8"

APP312 1/2"

- Torque: 95 Nm
- Weight: 1.26 kg
- Vibration: 1.13 m/s



PRO 3/8" & 1/2" RATCHETS

Easy to operate, this general purpose air ratchet features a forward/reverse action.

PRO air tool



Features

- Easy speed control
- Ball type retainer
- Easy forward/reverse shift
- Progressive throttle

Part Number Size Torque Free speed Vibration

APT320 3/8" 50/68 Nm 160 rpm 5.2 m/s

APT330 1/2" 60 Nm 150 rpm 5.2 m/s

PRESTIGE 3/8" LUMPHAMMER RACHET

A maximum torque of 258 Nm makes the PRESTIGE Lumphammer Ratchet the most powerful impact ratchet in its class. Capable of removing nuts that standard air ratchets simply can't, this lumphammer still allows access to areas normally unreachable with an impact gun. Ideal for small engine repairs, transmission work and overall automotive service work.

PRESTIGE air tool

Features

- Increased power
- Warm and comfortable to use
- Single handed forward and reverse setting
- Handle exhaust directs air away from work area

Part Number Size Torque Free speed Vibration

APP340 3/8" 258 Nm 4150 rpm 8.24 m/s





GRINDERS

PRESTIGE DIE GRINDER SET

This Die Grinder set features all the attributes of PCL's PRESTIGE range of Air Tools, such as reduced vibration and non-slip grip, whilst also incorporating a swivel exhaust, speed regulator and safety lever. Comes complete with hardened plastic case and a selection of accessories.



PRESTIGE air tool

Features

- Swivel rear exhaust
- Double bearing spindle
- Speed regulator
- Reduced vibration

Part Number	Size	Free speed	Weight	Vibration
APP700SET	6 mm	20,000 rpm	0.5 kg	3.15 m/s

PRO 4" & 7" ANGLE GRINDERS

Designed for the fabrication, cutting and grinding of steel and stone, this PRO unit's powerful motor makes light work of the toughest material.



PRO air tool



Features

- Side handle for ease of use and better balance.
- Excellent performance and durability
- Compatible with 4" or 7" cutting/grinding disks

Part Number	Disc Size	Free Speed	Weight	Vibration
APT715	4"	12,000 rpm	2 kg	2.34 m/s
APT716	7"	7,000 rpm	3.5 kg	3.3 m/s

PRO TYRE BUFFER

Designed for buffing and cleaning tyres, the PRO Tyre Buffer acts as a pre-preparation tool when re-treading tyres.

Features

- Powerful motor won't overheat when used for prolonged periods of time
- Composite body material, built to last
- Protective hose and cover
- Quick change chuck

PRO air tool



Part Number	Size	Free Speed	Weight	Vibration
APT740	7/16"	2,600 rpm	1 kg	5.4 m/s

PRO 6MM DIE GRINDER

Offering high free speed and low vibration, safety throttle lever with 6mm collet (3 piece design), this die grinder is designed for tyre buffing, polishing and grinding. Extremely versatile, the 6mm Die Grinder is an excellent choice for use in a confined workspace.

Features

- 6mm collet
- High free speed 22,000 rpm
- Safety throttle lever
- Low vibration

PRO air tool



Part Number	Size	Free Speed	Weight	Vibration
APT702	6 mm	22,000 rpm	0.5 kg	5.4 m/s

Couplings & Adaptors

Hose

Hose Fittings

Tyre Inflation Equipment

Tyre Care

Nitrogen Equipment

Workshop Equipment

Air Tools

Air Tool Accessories



AIR SANDERS

PRESTIGE PALM SANDER

Made from durable composite material, this central vacuum type palm sander with low noise output suits the serious professional working to the demands of a busy workshop.



APPLICATION » WORKSHOPS, MANUFACTURING, FACTORIES

PRESTIGE air tool

Features

- 12,000 RPM for swirl free finishes
- Reduced vibration
- Built in regulator for optimised power control
- Central vacuum type



Part Number	Size	Free Speed	Weight	Vibration
APP760	6"	12,000 rpm	0.71 kg	2.8 m/s

PRO 6" ORBITAL SANDER

The powerful PRO 6" Orbital Sander features a side handle for better control and balance. The 6" diameter pad is suitable for adhesive type backing pads.

Features

- Two handed operation
- Built in speed regulator
- Rear exhaust
- Insulated handle and motor housing
- Random orbit
- Positive lever action

PRO air tool



Part Number	Size	Free Speed	Weight	Vibration
APT720	6"	10,000 rpm	2 kg	4.4 m/s

PRO 10MM BELT TENSION SANDER

Designed for metal work fabrication, general sheet metal work and general sanding applications, the PRO Belt Tension Sander is competitively priced without compromising quality or performance. A simple tension mechanism ensures the belt maximises performance and prevents slippage.

Features

- Optimal positioning due to rotating handle
- Rear exhaust through handle
- Adjustable sanding arm
- Mechanism for quick and easy belt exchange
- Universal belt size 10 x 330 mm
- Maximum belt speed 16.5 m/s



Part Number	Size	Free Speed	Weight	Vibration
APT780	10 mm	17,000 rpm	0.94 kg	5.65 m/s

PRO 20MM BELT TENSION SANDER

As with the 10mm model, the PRO 20mm is designed for metal work fabrication, general sheet metal work and general sanding applications, and is competitively priced without compromise on quality or performance.

Features

- Optimal positioning due to rotating handle
- Rear exhaust through handle
- Adjustable sanding arm
- Mechanism for quick and easy belt exchange
- Belt size 20 mm x 480 mm



Part Number	Size	Free Speed	Weight	Vibration
APT781	20 mm	17,000 rpm	1.4 kg	5.65 m/s

Couplings & Adaptors

Hose

Hose Fittings

Tyre Inflation Equipment

Tyre Care

Nitrogen Equipment

Workshop Equipment

Air Tools

Air Tool Accessories



Couplings & Adaptors

Hose

Hose Fittings

Tyre Inflation Equipment

Tyre Care

Nitrogen Equipment

Workshop Equipment

Air Tools

Air Tool Accessories

DRILLS

PRO REVERSIBLE AIR DRILLS

A vital addition to any garage or workshop, these PRO reversible drills are designed for ease of use. The tool reverses with a simple flick of a switch, enabling the user to keep their eye on the target. Drill bits can be changed with the keyless chuck.



PRO air tool

Features

- 10mm or 13mm Jacobs keyless chuck
- Side mounted forward/reverse shift lever
- Ergonomic handle built for comfort
- Positive trigger action
- APT413R comes with additional rotatable handle for user comfort and precision

Part Number	Size	Free Speed	Weight	Vibration
APT401R	10 mm	1,800 rpm	1.2 kg	1.5 m/s
APT413R	13 mm	800 rpm	1.58 kg	1.5 m/s



APT401R



APT413R

PRESTIGE 10MM AIR DRILL

PCL's 10mm PRESTIGE Air Drill is a must for all workshops. Its ergonomic grip ensures comfort during prolonged use, whilst its size and robustness make it built to handle spring and front end work.



PRESTIGE air tool

APPLICATION » WORKSHOPS, PLANT HIRE

Features

- 10 mm Jacobs Keyless chuck
- Side mounted forward/reverse shift
- Reliable heat treated gear system
- Ideal for drilling and reaming

Part Number	Size	Free Speed	Weight	Vibration
APP405	10 mm	1,800 rpm	1.16 kg	0.9 m/s

PRO 10MM ANGLED AIR DRILL

The 10mm PRO reaches areas a regular drill struggles with. Perfect for awkward jobs, such as drilling out exhaust brackets, this drill is suited to workshop and small manufacturing applications.



PRO air tool

APPLICATION » WORKSHOPS, SMALL MANUFACTURING

Features

- Angled head for easy access
- Positive throttle
- 10mm / 3/8" chuck

Part Number	Size	Free Speed	Weight	Vibration
APT402	10 mm	1,700 rpm	1.3 kg	1.5 m/s



SCREWDRIVERS

PRESTIGE 1/4" HEX AIR SCREWDRIVER

This low noise, lightweight screwdriver is comfortable and convenient to use with ergonomic grip. It quickly switches to reverse with a convenient thumb lever, whilst a feather trigger gives enhanced control in delicate situations.

Part Number	Size	Torque	Weight	Vibration
APP409	1/4"	12 Nm	1.23 kg	0.08 m/s

PRESTIGE air tool

APPLICATION » WORKSHOPS, PLANT HIRE, FARMS

Features

- Externally adjustable torque setting range from 0-12 in 1 Nm increments
- Forward and Reverse mode
- One finger forward/reverse shift
- Reliable heat treated planetary gear machined from bar stock



PRO 1/4" HEX PISTOL SCREWDRIVER

Ideal for general workshops and body shops, the Hex Pistol Screwdriver provides forward and reverse action at the convenient flick of a switch.

PRO air tool

Features

- Spring compression determines torque setting
- Integrated holder for 1/4" bits
- Rear exhaust through handle
- Sensitive trigger mechanism
- Convenient forward/reverse shift



Part Number	Size	Maximum Torque	Weight	Vibration
APT407	1/4"	17 Nm	1.2 kg	4.6 m/s

PRO 1/4" HEX STRAIGHT SCREWDRIVER

With 17 Nm of torque, this traditional, straight screwdriver's robust aluminium cast body offers longevity in manufacturing environments for detail assembly work.

Features

- Maximum torque 17 Nm
- Rear exhaust
- Sensitive trigger
- Spring assisted torque setting



PRO air tool

Part Number	Size	Maximum Torque	Weight	Vibration
APT408	1/4"	17 Nm	1.1 kg	4.6 m/s

BODY SAWS

PRESTIGE AIR BODY SAW

Weighing in at an extremely lightweight 0.6kg, this PRESTIGE tool is perfect for the regular user looking for a professional body saw. Features include low vibration, high cutting capacity and adjustable rear exhaust for precision cutting under maximum control.

Features

- Low vibration
- Lightweight
- High cutting capacity
- Adjustable rear exhaust



PRESTIGE air tool

Part Number	Cutting capacity	Free speed	Weight	Vibration
APP600	1.2 mm	10,000 rpm	0.65 kg	1.59 m/s

PRO BODY SAW

PRO air tool

With its high cutting performance and well-balanced design, the PRO Air Body Saw is able to reach a 1.6mm cutting capacity with ease. Ideal for body shops and metal workshops and suitable for universal blades.

Features

- Excellent cutting performance driven by 9,000 rpm motor
- Insulated handle and anti-vibration cover
- Adjustable blade guide
- 10mm maximum stroke
- Safety cut out throttle lever



Part Number	Cutting capacity	Free Speed	Weight	Vibration
APT650	1.6 mm	9,000 rpm	0.7 kg	2.2m/s



CUTTING TOOLS

PRESTIGE 3" CUT OFF TOOL

Designed for sheet metal work and precision cutting up to 3", with a composite construction to withstand the rigours of a busy workshop or garage.

PRESTIGE air tool



Features

- Swivel rear exhaust
- Double bearing spindle
- Speed regulator
- Reduced vibration

Part Number	Size	Free Speed	Weight	Vibration
-------------	------	------------	--------	-----------

APP708	3"	21,000 rpm	0.8 kg	0.8 m/s
--------	----	------------	--------	---------

PRO 3" CUT OFF TOOL

PRO air tool

Ideal for light cutting tasks in tight spaces, the PRO Cut Off Tool accommodates 75mm cutting disks and is well-suited to workshops and garages.



Features

- Rear exhaust through handle
- For discs up to 75 mm diameter (up to 10 mm thick)
- Positive throttle action with safety feature
- Metal safety guard

Part Number	Size	Free Speed	Weight	Vibration
-------------	------	------------	--------	-----------

APT719	3"	20,000 rpm	1 kg	2.2 m/s
--------	----	------------	------	---------

PRO METAL SHEAR

PRO air tool

Designed for metal work fabrication and general sheet metal cutting, the PRO Metal Shear is a great choice for customising and making short work of large panels.

Features

- Ergonomic handle for operator comfort
- Heavy duty cutting blades for long life and reliable cutting (1.2 mm)
- Handle exhaust
- Fast cutting action



Part Number	Cutting capacity	Free Speed	Weight	Vibration
-------------	------------------	------------	--------	-----------

APT670	1.2 mm	2,000 rpm	2.2kg	4.1 m/s
--------	--------	-----------	-------	---------

PRO AIR NIBBLER

PRO air tool

Made for metal work fabrication and general sheet metal work, the PRO Air Nibbler tackles tight spaces and intricate shapes.



Features

- Push cutting operation
- Ideal for tight spaces and intricate shapes
- Quick change punch and die
- Powerful motor

Part Number	Cutting capacity	Free Speed	Weight	Vibration
-------------	------------------	------------	--------	-----------

APT660	1.2 mm	2,500 rpm	0.8 kg	4.1 m/s
--------	--------	-----------	--------	---------

NAIL & STAPLE GUNS

PRO NAIL & STAPLE GUN

Safety is key with the PRO Nail & Staple Gun, with its trigger device to prevent accidental firing of nails and staples and rubber grip handle. The lightweight, aluminium gun comes in a carrycase with oiler and starter pack of nails and staples.

Features

- 2-stage operation trigger to fire single or multiple staples/ nails
- Safety trigger device to prevent accidental firing of nails and staples

Part Number	Staple Capacity	Sound	Weight	Vibration
-------------	-----------------	-------	--------	-----------

APT850	10 - 40 mm	98.5 dBa	0.49 kg	2.5 m/s
--------	------------	----------	---------	---------



PRO air tool

Couplings & Adaptors

Hose

Hose Fittings

Tyre Inflation Equipment

Tyre Care

Nitrogen Equipment

Workshop Equipment

Air Tools

Air Tool Accessories



AIR HAMMERS

PRO AIR HAMMER

A general purpose air hammer for cutting, punching or chipping, the PRO Air Hammer comes with a coil spring retainer for fast and easy chisel changes - useful for body shop work such as rust removal.

PRO air tool



Features

- 3000 blows per minute
- 2 5/8" (3 mm) stroke length
- 10-11 mm shank opening
- Coiled spring chisel retainer

Part Number	Blows	Sound	Weight	Vibration
APT517	3,000 per minute	101.6 dBa	1.6 kg	3.75 m/s

PRO NEEDLE SCALER

Made for surface preparation this tool is perfect for workshops and paint shops.

Features

- 4000 blows per minute
- Straight handle
- Hardened self-adjusting needles

PRO air tool

PRO RIVETER

The tough and versatile PRO Air Riveter is designed for a multitude of applications with four riveting nozzles of different sizes. Ideal for general workshops or metal work fabrication and general sheet metal hole punching work.

Features

- Ergonomic design for operator comfort
- Lightweight
- Supplied with four riveting nozzles
- For rivets sized: 3/32" (2.4 mm), 1/8" (3.2 mm), 5/32" (4.0 mm), 3/16" (4.8 mm)

PRO air tool



Part Number	Traction power	Sound	Weight	Vibration
APT690	1940 lb	76 dBa	1.6 kg	1.3 m/s



PRO NEEDLE SCALER

Part Number	Impacts Per Minute	Sound	Weight	Vibration
APT561	4,600	85.5 dBa	2.6 kg	6.67 m/s

TOOL SETS

PRESTIGE DE-SCALING SET

Excellent for delaminating rust from steel, the de-scaling set's 19 needles remove rust with ease, and can be quickly and effortlessly changed to the hammer action chisels.

Features

- Reduced vibration
- Swivel inlet
- Unique balanced design
- Quick change retainer

PRESTIGE air tool

APPLICATION » WORKSHOPS, BODY SHOPS

Part Number	Stroke	Sound	Weight	Vibration
APP570SET	67 mm	96.3dBa	1.73 kg	4.84 m/s



Couplings & Adaptors

Hose

Hose Fittings

Tyre Inflation Equipment

Tyre Care

Nitrogen Equipment

Workshop Equipment

Air Tools

Air Tool Accessories



Couplings & Adaptors

MINI AIR TOOLS

Hose

MINI AIR RATCHETS

PCL's Mini Air Ratchets offer the ultimate in flexibility, allowing access to small areas often unreachable with conventional ratchets. The advanced and durable head and shoulder design provides dramatically longer life, whilst the soft grip gives users superior comfort and a non-slip feel. Suitable for the installation and repair of exhaust systems, radiators, water pumps, fuel pumps, transmissions, under-dashboard, small engine repair and all small fasteners.



Hose Fittings

Features

- Palm size ratchet allows the operator to reach small areas
- Ideal for confined conditions
- Compact and lightweight design allows maximum operator control and performance
- Rear exhaust to keep airflow away from work area
- Longer life
- Soft grip provides superior comfort and non-slip feel for operation
- High power motor for consistent performance

Part Number Size

APM100	1/4"
APM200	3/8"
APM300	1/2"

- Vibration: 7.2 m/s
- Sound: 85 dBa
- Weight: 0.4 kg
- Torque: 34 Nm

MINI air tool



Tyre Inflation Equipment

Tyre Care

MINI 6MM ANGLE DIE GRINDER

The angle version of the Mini 6mm Die Grinder offers the same outstanding performance along with optimum flexibility for operators - allowing access to small areas often unreachable by conventional die grinders.

MINI 6MM STRAIGHT DIE GRINDER

The Mini 6mm Straight Die Grinder is a prime example of the outstanding performance and quality expected from PCL. Offering the operator optimum flexibility, it allows access to small areas which are often unreachable with conventional die grinders.

Nitrogen Equipment

Workshop Equipment

Features

- Allows the operator to reach into very small areas
- Safety lever prevents any possible accidents
- Rear exhaust to keep airflow away from the hand
- High power motor designed for all tight grinding situations

MINI air tool



Part Number	Vibration	Sound	Weight	Free Speed
APM400	5.08 m/s	81 dBa	0.3 kg	19,000 rpm

Features

- Allows the operator to reach into very small areas
- Safety lever prevents any possible accidents
- Rear exhaust to keep airflow away from the hand
- High power motor designed for all tight grinding situations

MINI air tool



Part Number	Vibration	Sound	Weight	Free Speed
APT901	4 m/s	81 dBa	0.34 kg	25,000 rpm

Air Tools

Air Tool Accessories



MINI AIR TOOLS

MINI 2" ANGLE DIE GRINDER

The Mini 2" Angle Grinder offers the same outstanding performance and quality expected from PCL. The palm-size tool provides the operator with ultimate flexibility, allowing access to small areas, often unreachable by conventional grinders.

Features

- Palm size angle grinder allows the operator to reach small areas
- Compact and lightweight design allows maximum operator control and performance
- Rear exhaust to keep airflow away from work area
- High power motor for consistent performance, Ideal for smart repairers

MINI air tool



Part Number	Vibration	Sound	Weight	Free Speed
APM500	5.7 m/s	81 dBA	0.4 kg	16,500 rpm

MINI SANDERS



These Mini Sanders offer the same outstanding performance and quality expected from the PCL brand. Providing the operator with ultimate flexibility, it allows access to small areas often unreachable by conventional sanders.

MINI air tool

Features

- Small sanding pad allows the operator to reach small areas
- Medium sanding pad allows the operator to reach small areas whilst also maintaining surface area coverage
- Random orbit allows maximum operator control and finish
- Rear exhaust to keep airflow away from the hand
- High power motor designed for efficient sanding

Part Number	Size	Vibration	Sound	Weight	Free Speed
APM700	2"	7.2 m/s	81 dBA	0.34 kg	16,500 rpm
APT909	3"	7.2 m/s	81 dBA	0.34 kg	16,500 rpm



APM700



APT909

Couplings & Adaptors

Hose

Hose Fittings

Tyre Inflation Equipment

Tyre Care

Nitrogen Equipment

Workshop Equipment

Air Tools

Air Tool Accessories



MINI AIR TOOLS

Couplings & Adaptors

Hose

Hose Fittings

Tyre Inflation Equipment

Tyre Care

Nitrogen Equipment

Workshop Equipment

Air Tools

Air Tool Accessories

MINI 1/4" STRAIGHT DRILL

This palm-size Mini Straight 1/4" Air Drill offers the same outstanding performance and quality as its fellow tools in the PCL range. The 6.5mm drill offers the ultimate in operator flexibility, allowing access to small areas often unreachable by conventional drills.

Features

- Palm size drill allows the operator to reach small areas
- Compact and lightweight design allows maximum operator control and performance
- Rear exhaust to keep airflow away from work area
- High power motor for consistent performance



MINI air tool

Part Number	Vibration	Sound	Weight	Free Speed
APT904	1.5 m/s	81 dBa	0.43 kg	6,000 rpm

MINI 1/4" ANGLE DRILL

PCL's 1/4" Mini Angle Drill offers the usual outstanding performance and quality expected from the world-leading brand. The palm-size drill offers the operator ultimate flexibility, allowing access to small areas often unreachable by conventional drills.

Features

- Palm size drill allows the operator to reach small areas
- Compact and lightweight design allows maximum operator control and performance
- Rear exhaust to keep airflow away from work area
- High power motor for consistent performance



MINI air tool

Part Number	Vibration	Sound	Weight	Free Speed
APM800	4.7 m/s	81dBa	0.7 kg	4,500 rpm

MINI 3" ANGLE CUTTER

This Mini 3" Angle Cutter offers the same outstanding performance and quality, expected from the market-leading PCL brand. The palm-size cutter offers the operator ultimate flexibility, allowing access to small areas often unreachable by conventional cutters.

Features

- Palm size cutter allows the operator to reach small areas
- Compact and lightweight design allows maximum operator control and performance
- Rear exhaust to keep airflow away from work area
- High power motor for consistent performance



MINI air tool

Part Number	Vibration	Sound	Weight	Free Speed
APM600	5.08 m/s	81 dBa	0.4 kg	16,500 rpm

TOP SAFETY TIP

Health and safety guidelines recommend fitting an Air Tool Whip Hose between the air tool and coupling to distance the tool from its air supply - thus preventing dangerous pneumatic hose whip incidents.

Find out more about Air Tool Whip Hoses on page 28





PNEUMATIC CARTRIDGE CAULK GUN DISPENSERS

GREASE GUN

PCL's Pneumatic Grease Gun features 3-way loading with continuous feed and 360-degree handle rotation. The air powered grease gun simplifies the task of lubrication, providing superior flow control and the convenience of fully automatic operation, with pistol grip and single pulse trigger operation.



Features

- 360° handle rotation
- Supplied with two nozzles: offset and flexi
- Pistol grip and single pulse trigger operated
- Angled design with die cast body and head
- Grease loads easily with standard 14 oz (400 cc) cartridge, also bulk or pump fill
- Continuous flow grease applied under a steady pressure
- Suitable for medium grease, 2,400 to 6,000 psi delivery from 60 to 150 psi feed (40:1 pressure ratio)

Part Number	Vibration	Sound	Maximum load volume	Weight
APT813	3.5 m/s	79 dBa	14oz	1.5 kg

COMPRESSED AIR SEALING GUN

For use with all types of sealants and glues from commercially available 310ml original cartridges.



Features

- For 310 ml original cartridges
- Telescopic piston
- Integrated regulating valve for the use of universal sealants

Part Number	Maximum Inlet Pressure	Cartridge Volume	Weight
012 032 011	10 bar / 145 psi	310 ml	1.41 kg

310ML CARTRIDGE CAULK GUN DISPENSER

PCL's 310ml Cartridge Caulk Gun Dispenser has independent control valves for the air and material enabling precise individual fine control to suit the particular application in hand. The air feed ensures the material is distributed equally on the surface to be coated, ensuring optimum adhesion without air bubbles and capillaries.



Features

- For 310 ml baulk cartridges
- Integrated control valves

Part Number	Maximum Inlet Pressure	Cartridge Volume	Weight
012 031 011	10 bar / 145 psi	320 ml	0.69 kg

TELESCOPIC MULTI-FUNCTION CARTRIDGE GUN

PCL's telescopic gun has separate control valves for the air and material feed, allowing precise individual fine control to suit specific applications. The telescopic cylinder for the material feed ensures the sealant and compressed air are hermetically separated. The air spray evenly distributes the material on the surface to be coated, guaranteeing optimum adhesion without air bubbles and capillaries. For materials from 310ml caulking tube cartridges.

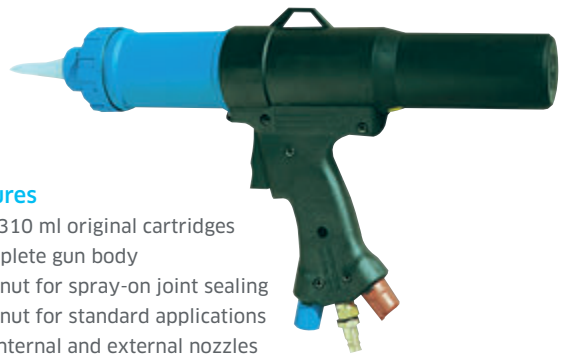

Features

- For 310 ml original cartridges
- Complete gun body
- Cap nut for spray-on joint sealing
- Cap nut for standard applications
- 10 internal and external nozzles

Part Number	Maximum Inlet Pressure	Cartridge Volume	Weight
012 043 011	10 bar / 145 psi	310 ml	1.65 kg

Couplings & Adaptors

Hose

Hose Fittings

Tyre Inflation Equipment

Tyre Care

Nitrogen Equipment

Workshop Equipment

Air Tools

Air Tool Accessories

AIR TOOL ACCESSORIES

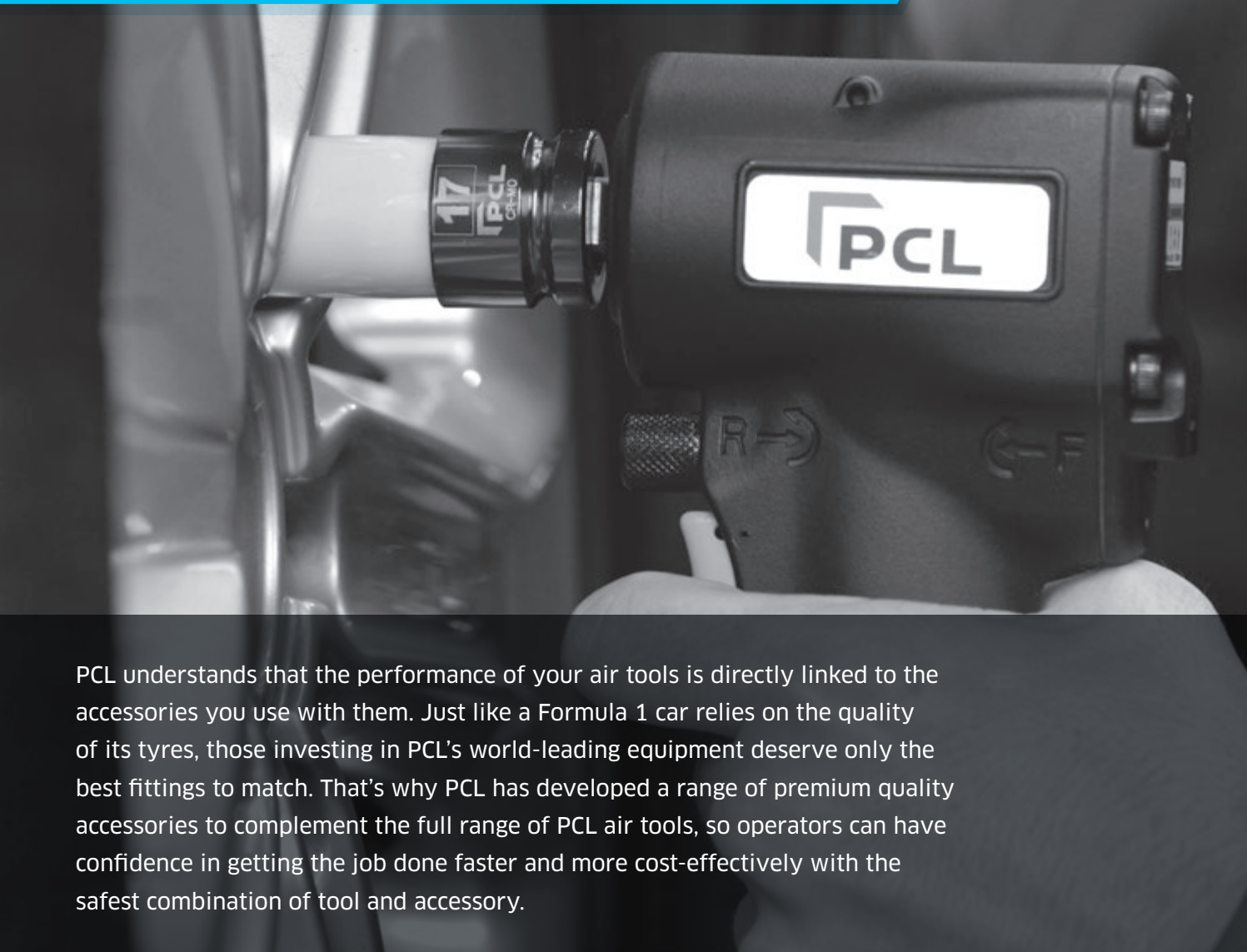

PCL understands that the performance of your air tools is directly linked to the accessories you use with them. Just like a Formula 1 car relies on the quality of its tyres, those investing in PCL's world-leading equipment deserve only the best fittings to match. That's why PCL has developed a range of premium quality accessories to complement the full range of PCL air tools, so operators can have confidence in getting the job done faster and more cost-effectively with the safest combination of tool and accessory.



3 Piece 1/2" Drive Alloy Wheel Impact Socket Set

Page

110



1/2" Drive Alloy Wheel Impact Sockets

Page

110



18 Piece 1/2" Drive Impact Socket Set

Page

111



10 Piece 1/2" Drive Deep Impact Socket Set

Page

111



1/2" Drive Deep Impact Sockets

Page

111

BEST SELLER

3 PIECE 1/2" DRIVE ALLOY WHEEL IMPACT SOCKET SET

Page 110



3/4" Drive Deep Impact Sockets

Page 112



4 Piece 1" Drive Deep Impact Socket Set

Page 112



1" Drive Deep Impact Sockets

Page 112



3/4" Drive Extension Bar

Page 112



32T Bimetallic Saw Blades

Page 112



5 piece Chisel Set

Page 113



6" / 150 mm Sanding Pads

Page 113



2" / 50mm Depressed Centre Metal Grinding Wheels

Page 113



3" / 75mm Extra Thin Flat Metal Cutting Discs

Page 113



3" Buffing Accessory Pack

Page 114



2" & 3" Velcro Backing Pads

Page 114



Mini Speed Regulator

Page 114



Air Tool Oil

Page 114

Air Tool Accessories



Couplings & Adaptors

Hose

Hose Fittings

Tyre Inflation Equipment

Tyre Care

Nitrogen Equipment

Workshop Equipment

Air Tools

Air Tool Accessories

IMPACT SOCKETS

3 PIECE 1/2" DRIVE ALLOY WHEEL IMPACT SOCKET SET

BEST SELLER

This high quality 3 Piece 1/2" Drive Alloy Wheel Impact Socket Set is made from high grade hardened chrome molybdenum steel for longer life, with sockets encased in a protective plastic sleeve to prevent damage to alloy wheels. The set includes the 3 most popular sizes of impact sockets for a 1/2" drive impact wrench.

Features

- Impact rated 6 point chrome molybdenum sockets for longer life
- Features two grease rings for superior user grip
- Centre hole is punched through for extra depth on the work surface
- Offers Z-Drive, contacting the flat walls of fasteners for stronger grip
- Thin wall design with chamfered openings for easier mating to fasteners
- 3 socket sizes to cover most standard wheel nut sizes



Part Number Kit Contents

APA12 x3 Sockets - sizes included (mm): 17, 19 & 21

WHAT IS THE DIFFERENCE BETWEEN IMPACT SOCKETS AND REGULAR SOCKETS?



The wall of an impact socket is around 50% thicker than that of a regular socket, making it suitable for use with pneumatic impact tools, whereas regular sockets should only be used on hand tools. This difference is most noticeable in the corner of the socket where the wall is thinnest. It is the first place where cracks would develop due to vibrations during use.

Impact sockets are constructed with chrome molybdenum steel, a ductile material that adds additional elasticity to the socket and tends to bend or stretch rather than shatter. This also helps to avoid unusual deformation or damage to the tool's anvil. Regular sockets are usually made from chrome vanadium steel, which is structurally strong but generally more brittle, and therefore prone to breaking when exposed to shock and vibration.

Another noticeable difference is that impact sockets have a cross hole in the handle end, for use with a retaining pin and ring, or locking pin anvil. This allows the socket to remain securely attached to the impact wrench anvil, even under high stress situations.

1/2" DRIVE ALLOY WHEEL IMPACT SOCKETS

Designed to fit any 1/2" impact wrench, PCL's 1/2" Drive Alloy Wheel Impact Sockets are manufactured from high grade hardened chrome molybdenum steel for longer life, and encased in a protective plastic sleeve to prevent damage to alloy wheels.

Features

- Chrome molybdenum material for longer life
- Thick walls prevent breakage
- For use with 1/2" impact wrenches
- Colour coded for quick & easy size identification

Part Number	Size (mm)
APA12/17	17
APA12/19	19
APA12/21	21





IMPACT SOCKETS

18 PIECE 1/2" DRIVE IMPACT SOCKET SET

From 10 mm to 32 mm, this high quality 18 Piece 1/2" Drive Impact Socket Set covers everything you would require for a 1/2" drive, and comes in a professional carry case with individually labelled moulds for easy identification.

Features

- Impact rated 6 point chrome molybdenum sockets for longer life
- All PCL sockets exceed ANSI specifications
- Features two grease rings for superior user grip
- Centre hole is punched through for extra depth on the work surface
- Offers Z-Drive, contacting the flat walls of fasteners for stronger grip
- Thin wall design with chamfered openings for easier mating to fasteners

Part Number Kit Contents

APA10	x1 1/2" Extension bar x17 Sockets - sizes included (mm): 10, 11, 12, 13, 14, 15, 16, 17, 18, 19, 21, 22, 23, 24, 27, 30, 32
-------	--

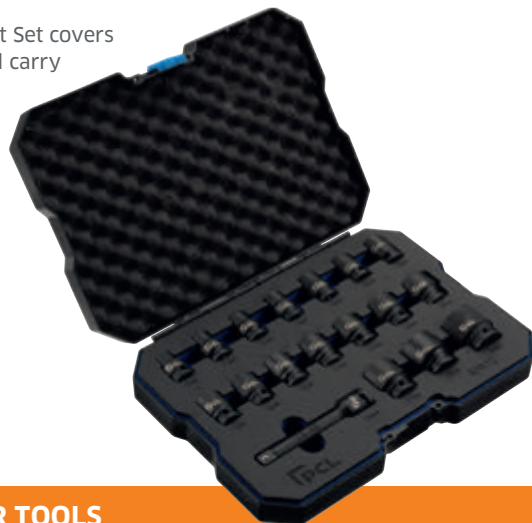

WHY IT IS VITAL TO ONLY USE IMPACT SOCKETS ON AIR TOOLS

Using impact sockets helps to achieve optimal tool efficiency but most importantly, ensures safety in the workspace. They are specifically designed to withstand the vibration and shock of each impact, preventing cracks or breaks, thereby prolonging the life of the socket and avoiding damage to the tool's anvil.

Impact sockets can be used safely on a hand tool, however you should never use a regular socket on an impact wrench as this can be extremely dangerous. A regular socket is likely to shatter when used on power tools due to their thinner wall design and the material they're made from. This could be a serious safety risk for everyone using the same workspace as cracks in the socket could cause it to rupture at any time causing severe injuries.



10 PIECE 1/2" DRIVE DEEP IMPACT SOCKET SET

From 10 mm to 24 mm, this high quality 10 Piece 1/2" Drive Deep Impact Socket Set covers everything you would require for a 1/2" drive, and comes in a professional carry case with individual labelled moulds for easy identification.

Features

- Impact rated 6 point chrome molybdenum sockets
- All PCL sockets exceed ANSI specifications
- Features two grease rings for superior user grip
- Centre hole is punched through for extra depth on the work surface
- Offers Z-Drive, contacting the flat walls of fasteners for stronger grip
- Thin wall design with chamfered openings for easier mating to fasteners

Part Number Kit Contents

APA11	x10 Sockets - sizes included (mm): 10, 11, 12, 13, 14, 17, 19, 21, 22 & 24
-------	--

1/2" DRIVE DEEP IMPACT SOCKETS

Designed to fit any 1/2" impact wrench, PCL's 1/2" Drive Deep Impact Sockets are manufactured from high grade hardened chrome molybdenum steel for longer life.

Features

- Chrome molybdenum material for longer life
- Thick walls prevent breakage
- For use with 1/2" impact wrenches
- PCL branded with sizes printed clearly on body of socket

Part Number Size (mm)

APA11/12	12
APA11/13	13
APA11/15	15
APA11/17	17
APA11/19	19
APA11/21	21
APA11/22	22
APA11/24	24



Couplings & Adaptors

Hose

Hose Fittings

Tyre Inflation Equipment

Tyre Care

Nitrogen Equipment

Workshop Equipment

Air Tools

Air Tool Accessories



Couplings & Adaptors

Hose

Hose Fittings

Tyre Inflation Equipment

Tyre Care

Nitrogen Equipment

Workshop Equipment

Air Tools

Air Tool Accessories

IMPACT SOCKETS

3/4" DRIVE DEEP IMPACT SOCKETS

Designed to fit any 3/4" impact wrench, PCL's 3/4" Drive Deep Impact Sockets are manufactured from high grade hardened chrome molybdenum steel for longer life and durability.

Features

- Chrome molybdenum material for longer life
- Thick walls prevent breakage
- For use with 3/4" impact wrenches
- PCL branded with sizes printed clearly on body of socket

Part Number	Size (mm)
APA30/27	27
APA30/30	30
APA30/32	32
APA30/33	33



1" DRIVE DEEP IMPACT SOCKETS

Designed to fit any 1" impact wrench, PCL's 1" Drive Deep Impact Sockets are manufactured from high grade hardened chrome molybdenum steel for longer life.

Features

- Chrome molybdenum material for longer life
- Thick walls prevent breakage
- For use with 1" impact wrenches
- PCL branded with sizes printed clearly on body of socket

Part Number	Size (mm)
APA40/24	24
APA40/27	27
APA40/30	30
APA40/33	33
APA40/34	34
APA40/36	36
APA40/38	38



4 PIECE 1" DRIVE DEEP IMPACT SOCKET SET

PCL's high quality 4 Piece 1" Drive Deep Impact Socket Set includes the most popular sizes suitable for a 1" drive impact wrench.

Features

- Impact rated 6 point chrome molybdenum sockets for longer life
- All PCL sockets exceed ANSI specifications
- Features two grease rings for superior user grip
- Centre hole is punched through for extra depth on the work surface
- Offers Z-Drive, contacting the flat walls of fasteners for stronger grip
- Thin wall design with chamfered openings for easier mating to fasteners

Part Number	Kit Contents
APA40	x4 Sockets - sizes included (mm): 27, 30, 32, 33



3/4" DRIVE EXTENSION BAR

PCL's 3/4" drive extension bar is a handy addition to any workshop toolbox, allowing the user to access those hard to reach deep-set bolts.



Features

- For use with 3/4" drive impact wrenches
- Manufactured from high grade hardened chrome molybdenum steel for longer life

Part Number	Square Drive	Length
APA50	3/4 in	6 in / 150 mm

32T BIMETALLIC SAW BLADES

This pack of 32T Bimetallic Pneumatic Reciprocating Saw Blades is suitable for use with both PCL and other brand air body saws.

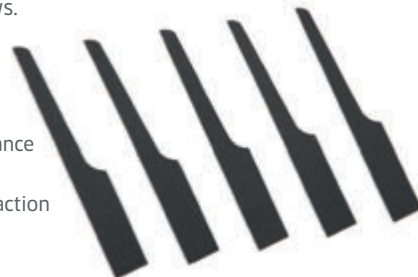

Features

- Excellent performance
- Universal fitment
- Fast clean cutting action

Part Number	Size (mm)
APT32	95 x 13 x 32 Teeth



AIR TOOL CONSUMABLES



5 PIECE CHISEL SET

This 5 Piece Chisel Set is suitable for use with both PCL and other brand air hammers.

Features

- Supplied in a tool roll
- Chisel shank size 401" Parker Taper
- Chrome Molybdenum forged for longer life

Part Number	Shank Size	Length	Diameter
APT20	401 in Parker Taper	175 mm	10 mm



2" / 50MM DEPRESSED CENTRE METAL GRINDING WHEELS

These 2" / 50 mm Depressed Centre Metal Grinding Wheels are suitable for use with both PCL and other brand grinders.

Features

- Excellent performance and life
- Quantity per pack: 5

Part Number	Diameter	Bore
APA102	2 in / 50 mm	10 mm



6" / 150 MM SANDING PADS

These Backing Pads are suitable for 6"/150 mm diameter air sanders.

Features

- For use with self adhesive and velcro sanding papers
- Excellent durability and balance

Part Number	Description	Diameter	Thread Size
APT90V	Velcro backing pad	6 in / 150 mm	5/16 in
APT90A	Self-adhesive backing pad	6 in / 150 mm	5/16 in



3" / 75MM EXTRA THIN FLAT METAL CUTTING DISCS

Manufactured in Europe to OSA safety standards, these extra thin cutting discs have been developed for extremely fast, high precision cutting of sheet metal, with strengthened core stability for reduced vibration.

Features

- Suitable for use with PCL and other brand air cutting tools
- Exceptional performance and life
- Fast and precise cutting blades for stainless and mild steel, steel sheets or bars on new or rusty surfaces
- Quantity per pack: 10

Part Number	Diameter	Bore
APT75FCM	3 in / 75 mm	10 mm

Couplings & Adaptors

Hose

Hose Fittings

Tyre Inflation Equipment

Tyre Care

Nitrogen Equipment

Workshop Equipment

Air Tools

Air Tool Accessories



AIR TOOL CONSUMABLES

Couplings & Adaptors

Hose

Hose Fittings

Tyre Inflation Equipment

Tyre Care

Nitrogen Equipment

Workshop Equipment

Air Tools

Air Tool Accessories



3" BUFFING ACCESSORY PACK

Containing two different grades of sponge pad, a lambswool pad and a spare 3" backing pad, this Buffing Accessory Pack is ideal for use with sanders.

Features

- Velcro backing pad allows simple removal and attachment of buffing pads
- High grade sponge and lambswool pads for efficient buffing
- Felt backed buffing pads for easy transfer to backing pad

Part Number	Pad Diameter	Thread Size
APA92	3 in / 75 mm	M8



2" & 3" VELCRO BACKING PADS

The 2" and 3" Velcro Backing Pads are ideal for quick transfer of sanding discs and have been designed for use with PCL's Mini Sanders.

Features

- Hardened composite body material
- Standard threaded end to fit the Mini Sander
- High grade velcro material

Part Number	Pad Diameter	Thread Size
APA93	2 in / 50 mm	M6
APA94	3 in / 75 mm	M6

MAINTENANCE

MINI SPEED REGULATOR

PCL's Mini Speed Regulator turns a powerful sander into a precision buffing tool. Designed to reduce the free speed of air tools with a 1/4" thread, it regulates airflow to the tool.



Features

- Heavy duty steel material
- Simple operation
- Speed wheel allows simple increase or decrease of free speed
- Heavy duty steel design

Part Number	Thread Size	Thread Type
APA91	1/4 in	Male

AIR TOOL OIL

PCL's premier quality ISO 22, naturally low viscosity Air Tool Oil is suitable for the lubrication of pneumatic tools, hydraulic systems, valves and equipment.



Features

- Suitable for the lubrication of pneumatic tools, hydraulic systems, valves and associated equipment
- Naturally low viscosity
- Blended with inhibitors
- Formulated to ensure rapid formation of a mist for lubrication of downstream pneumatic equipment

Part Number	Description
ISO221L	1 Litre ISO 22 Air Tool Oil

The PCL heritage

With over 80 years of experience in developing sophisticated pneumatic equipment, PCL is recognised as the global leader in the design and manufacture of the most advanced and comprehensive portfolio of tyre inflation and compressed air products on the market. Its products are a familiar sight on garage forecourts, tyre shops, factories and workshops around the world. The trusted "Made in Sheffield" PCL brand has become synonymous with superior products backed by first class service and local technical support, wherever its customers are based.

Founded in 1938 when the very first pressure gauges were designed and manufactured in Sheffield, PCL has experienced phenomenal growth, joining the HORNGROUP of companies, along with the TECALEMIT brand in 2011. Today PCL exports to over 100 countries through a worldwide network of agents and distributors, with manufacturing facilities in England, Germany, USA, India and China; whilst remaining firmly committed to its roots, manufacturing from its state-of-the-art production facility and HQ in Sheffield.

PCL employs a highly skilled workforce and is dedicated to providing reliable and competitively priced solutions for every application and level of activity. For customers, this means access to old favourites in addition to ground-breaking new products and ranges, including electronic tyre inflation, air tools, air treatment and nitrogen.

As a dynamic, forward-thinking company, PCL continues to expand, investing in product development and international capabilities to meet customer needs.

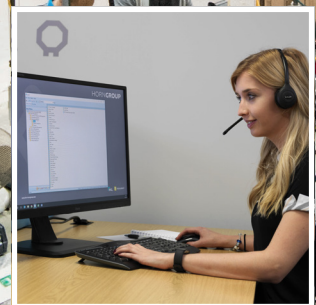

PCL's global network of distributors provides customers with first-class local service



Contact your local PCL distributor

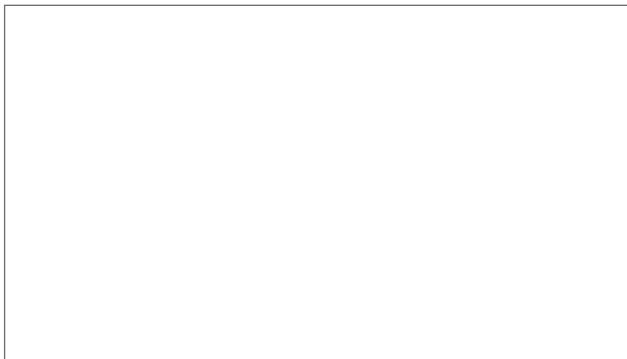

All orders are subject to our standard terms & conditions - available on request. All product specifications are subject to change without notice. Published July 2021. E. & O.E.

Pneumatic Components Limited
Holbrook Rise
Holbrook Industrial Estate
Sheffield S20 3GE

T +44 (0)114 248 2712
sales@pclairtechnology.com
www.pclairtechnology.com



A HORN GROUP BRAND

PCLCAT012 V1